

SHORT FORM CATALOG



October 2022 Edition

TABLE OF CONTENTS

Product Index – Alphanumeric	2
Unidirectional TVS Device Selection Process.....	5
Bidirectional TVS Device Selection Process	6
Solutions by Application.....	7
TVS Diode Arrays.....	12
Steering Diode Hybrids.....	34
Chipscale TVS Arrays.....	41
Steering Diodes.....	43
EMI Filter/TVS Arrays	47
Thyristor Surge Suppressors.....	48
High Powered Components.....	50
High Powered Modules	57
Standards and Waveforms	60
Product Packaging	63

ADDITIONAL INFORMATION

1. Not all voltages, configurations or packages are shown. Please contact customer service for more information.
2. ProTek offers protection devices for Automotive applications. The part numbers begin with the prefix 'PAM'.
3. ProTek offers protection devices for LED applications. The part numbers begin with the prefix 'PLED'.
4. The majority of ProTek's package configurations are ROHS and REACH compliant. Please refer to the product specification to determine which product is ROHS/REACH compliant.
5. Standard Tape & Reel Nomenclature
 - a. -T7 for 7" Reels, i.e., PSOT05-T7
 - i. -T71 for 7" Reels 1,000 pieces per reel, i.e., ESD4-LFC-T71
 - ii. -T73 for 7" Reels 3,000 pieces per reel, i.e., ESD4-LFC-T73
 - b. -T13 for 13" Reels, i.e., SM8LC05-T13
 - c. -TS for sample size Reels, i.e., SM16LC05C-TS
 - d. Not all products are available in 7" or 13" reels. Quantities per reel vary depending upon package configuration size. Please consult the product datasheet or customer service for ordering information regarding a specific part series.
6. Do not put products into life support systems without written consent from ProTek Devices.

ALPHANUMERIC - INDEX

1.0SMBJxxA/CA Series	50	LCD Series	16
1.5KExxA/CA Series	50	MAD1108	44
1.5SMCxxA/CA Series	50	MAD Series	44
100KS200CNH	58	MMAD1108	44
15KPxxA/CA Series	58	MMAD Series	44
15KPAxxA/CA Series	50	MSMF Series	16
232B & E	57	MSMFxxC Series	16
30KPAxxA/CA Series	50	MSMF05LC	16
420E Series	57	MSMF05LCC	16
420LB & LE Series	57	P0201D05C	16
422B & E	57	P0201V05	16
422ELC	57	P0402FCxxC Series	41
485ELC	57	P0402V Series	16
5.0SMDJxxA/CA Series	50	P0402VP24	16
587B Series	57	P0404FCxxC Series	44
587BLP Series	57	P0603V24	17
587BLPE Series	57	P15KPxxA/CA Series	51
5KPxxA/CA Series	50	P30KPxxA/CA Series	51
60KS200C & 90KS200C	58	P4KExxA/CA Series	51
704 Series	58	P4SMAxxA/CA Series	52
704-15K36P	58	P5V0S1UL	17
CPxx/C Series	12	P5V0S1ULC	17
DA16 Series	12	P6KExxA/CA Series	52
DA8 Series	12	P6SMBxxA/CA Series	52
DALC112S1	43	PAM01SC7905C	17
DD3K Series	51	PAM02SD23xx/C Series	17
DFN6-36	13	PAM03SD23xxCI Series	17
DFN8-36	13	PAM04DF100524	34
DL0521P	13	PAM05SC700504F	34
DLZ Series	51	PAM08SD23xx/C Series	17
DSL03-24	34	PAM10ST23xxC Series	17
DSL03-24T	34	PAM12SO824	18
DSL70	43	PAM13ST2305	34
DSOT0502	13	PAM15ST4305	34
EBLCxxC Series	13	PAM17DF2LC05C	18
EM02-100	47	PAM18DF2L0521	18
EM1631-08D5LP	47	PAM18DF2L0621	18
EM4D-100L	47	PAM19DF2L0521P	18
EM4DLP-100L	47	PAM1CAN	18
EM8D-100L	47	PAM1FLEX	18
EM8DLP-100L	47	PAM1IVN27	18
EM8D5LP-100L	47	PAM1LIN	18
EM8Q-100	47	PAM21SC790501H	19
ESD4-DFN	13	PAM28DOACxxA/CA Series	52
ESDA05C-5	13	PAM29DOAAxxA/CA Series	52
ESOT12LCC-1	13	PAM2CAN	19
ESOT24LCC-2	14	PAM2IVN24	19
ESOT3.3LC-2	14	PAM2LIN	19
ESOT3.3LCC	14	PAM30DOABxxA/CA Series	52
ET108	43	PAM31DOABxxA/CA Series	52
ET720	43	PAM32DOABxxA/CA Series	52
ET721	43	PAM33DOABxxA/CA Series	53
ET723	43	PAM35DOABxxA/CA Series	53
ET724	43	PAM36DOAAxxA/CA Series	53
GBLCxx/C Series	14	PAM37SDxxAL/CAL Series	19
GBLCxxCDN Series	14	PAM38DOAC10Y	45
GBLCxxCDSL Series	14	PAM3CAN	19
GBLC15CDSL	14	PAM4SMAxxA/CA Series	53
GBLCxxCIDFN Series	14	PAM5SxxA Series	53
GBLC03CIDNHP	14	PAM6SxxA Series	53
GBLC03CIHP	15	PAM8SxxA Series	53
GBLCxxHP/CHP Series	15	PAZC099	34
GBLCxx/CI Series	15	PBYG10Y	45
GBLCxxLC/CLC Series	15	PDFN2-32	19
GBLCSC08CLC	15	PDFN3-32	19
GBLCSCxx/C Series	15	PDLC05	19
GBLLC03/C Series	15	PDTV5xxCA Series	53
GPZ1275	58	PES1 Series	45
GPZ1275B60K	58	PESD05B	20
GPZ532	58	PESD05BLC	20
IO6LC	43	PESD05BULC	20
K Series	51	PESD12LCB	20
LCA Series	15	PESD12ULC	20

PRODUCT INDEX - ALPHANUMERIC

PESD1CAN	20	PRSB6.8CT	24
PESD1FLEX	20	PRSB6.8D	24
PESD1LIN	20	PRUSB05UBK	36
PESD2402	20	PSB15-LC	37
PESD24V	20	PSDxx/C Series	24
PESD27V	21	PSDxx61 Series	25
PESD2CAN	21	PSDxxHP Series	25
PESD3V3	21	PSLCxx/C Series	25
PGBT2504	34	PSLIC1	49
PHCR Series	57	PSM712	25
PHP & PIP Series	59	PSMDA05-6	25
PHS5xx/C Series	54	PSMDAxxC-4 Series	25
PHYTVSxxxV3 Series	54	PSMDAxxC-8 Series	25
PHYTVSxxxV4 Series	54	PSMF05	26
PLC01-6	21	PSMFxxAL/CAL Series	26
PLC03-3.3	21	PSMFxxBL/CAL Series	26
PLC03-3.3-DFN	21	PSMP30-240	49
PLC03-3.3H	21	PSMSxx/C Series	26
PLC03-3.3V	21	PSOTxx/C Series	26
PLC03-xxLC Series	22	PSOTxx3/C3 Series	26
PLC03-6	34	PSOT05CLP	26
PLC496	22	PSOT05LCC	27
PLC497	35	PSOT05ULC	27
PLCDA Series	22	PSOTxxKCA Series	27
PLCDAxxC-6 Series	22	PSOTxxLC Series	27
PLED05F189	41	PSR05	37
PLED0xx11PU Series	41	PSR05LC	37
PLED508	41	PSR3.3	37
PLED508U	41	PSRDA70-4	46
PLED511	41	PSRDAXX-4 Series	37
PLED511U	41	PSRDAXX-4A Series	37
PLEDxx31X23NB	41	PSRDAXX-6 Series	37
PLR0502	35	PSRDAXX-6A Series	37
PLR0502-6	35	PSRVxx-2LC Series	38
PLR0503	22	PSSB05P	27
PLR0504F	35	PTVSxxA Series	27
PLR0504PLCN	35	PUSB05UBK	38
PLR0506	35	PUSB403	38
PLR0506LC	35	PUSB06B	38
PLR0506LP	35	RSB6.8B	27
PLR0508	35	RSB6.8G	27
PLR0514LC	36	RSB6.8S	28
PLR0521	22	SKC Series	54
PLR05214LC	22	SLVDA2.8LC	28
PLR0521E	22	SLVU2.8	28
PLR0521U	23	SLVU2.8-4	28
PLR0524	36	SLVU2.8-4G	28
PLR0524P	36	SLVU2.8-4LC	28
PLR0621	23	SLVU2.8-8	28
PLR1524	23	SLVU2.8-8G	28
PLR2210	23	SM10KWxxA/CA Series	54
PLR2504	36	SM10KWExxA/CA Series	54
PLRxx12 Series	23	SM14MxxC Series	29
PLR2512H	23	SM15KWExxA/CA Series	54
PLR3304	36	SM16xx/C Series	29
PLR3304PLCN	36	SM16LCxx/C Series	29
PLR3311	23	SM30KWExxA/CA Series	55
PLR3343	36	SM3KWxxA/CA Series	55
PLR4045	36	SM5KWxxA/CA Series	55
PLRT0504LC	36	SM5SxxA Series	55
PLW0501D	23	SM6SxxA Series	55
PLW0501H	24	SM8LC Series	29
PLW0501P	24	SM8SxxA Series	55
PLW1201H	24	SMAJxxA/CA Series	55
PLW2.8	24	SMBJxxA/CA Series	55
PMAD1108	45	SMCJxxA/CA Series	56
PMAD Series	45	SMDAxx/C Series	29
PMMAD1108	46	SMDAxx-6 Series	30
PMMAD Series	46	SMDAxxCM Series	30
PNH1275 & PNH1275B	59	SMDAxxCN-5 Series	30
PP-SM Series	48	SMDAxxLC/LCC Series	30
PPZ516 & PPZ516B	59	SMDBxx/C Series	30
PRSB6.8C	24	SMDB712C	30

PRODUCT INDEX - ALPHANUMERIC

SMDD3KxxA Series	56
SMDJxxA/CA Series	56
SMEJxxA/CA Series	56
SMFxxC Series	31
SMLCxxC-2 Series	31
SMP6LCxx-2P Series	31
SMP6LLCxx-2P Series.....	31
SMSxx/C Series.....	31
SR12	38
SR Series.....	38
SR70	46
SRV05-4.....	38
SRV05-4-A.....	38
SRV05-4LC	39
SRV05-4M	39
SRV2.8-4.....	39
SRV25-4.....	39
SRV25-4LC	39
SRV3.3-4.....	39
STF701	47
TEL185B & E	58
TEL50B & E	58
TRV24-2LC	39
TRV24-4LC	40
TRVxx-4LC Series	40
U0402FCxxC Series.....	42
USB002	46
USB004	46
USB04xx/C Series.....	31
USB208	46
USB508xx/C Series.....	31
VSIP Series.....	32
VSB06P05LCI	32
VSMF05LC	33
VSMF05LCC	33

UNIDIRECTIONAL TVS DEVICE SELECTION PROCESS

TVS Clamping Characteristics

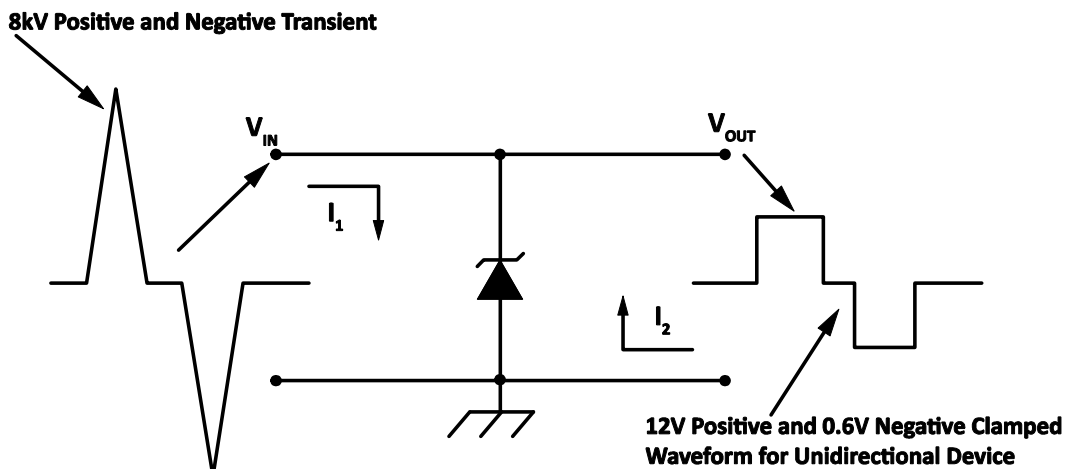

Unidirectional TVS



Avalanche Junction TVS VI Characteristics

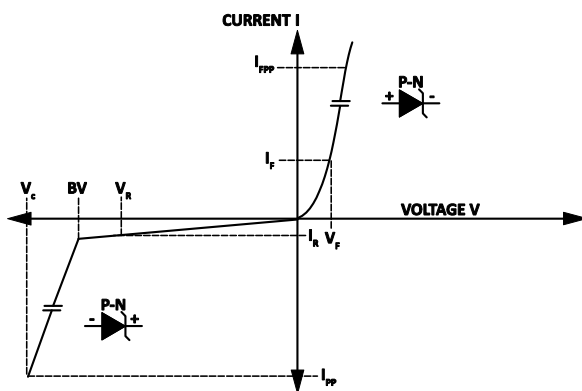

Symbol

B_V
 I_R
 V_R
 V_C
 I_{PP}

Parameter

Breakdown Voltage
 Leakage Current
 Reverse Stand-Off Voltage
 Clamping Voltage
 Peak Pulse Current

SELECTION PROCESS

TVS Parameters

Stand-Off Voltage (V_R) \geq
 Peak Pulse Current (I_P) \geq
 Clamping Voltage (V_C) \leq
 Input Capacitance of the Device \leq

Application Parameters

Operating Voltage (V_{OP})
 Transient Current (I_T)
 Voltage Withstand Level (V_{WS})
 Acceptable Line Loading for Functional Pass

BIDIRECTIONAL TVS DEVICE SELECTION PROCESS

TVS Clamping Characteristics

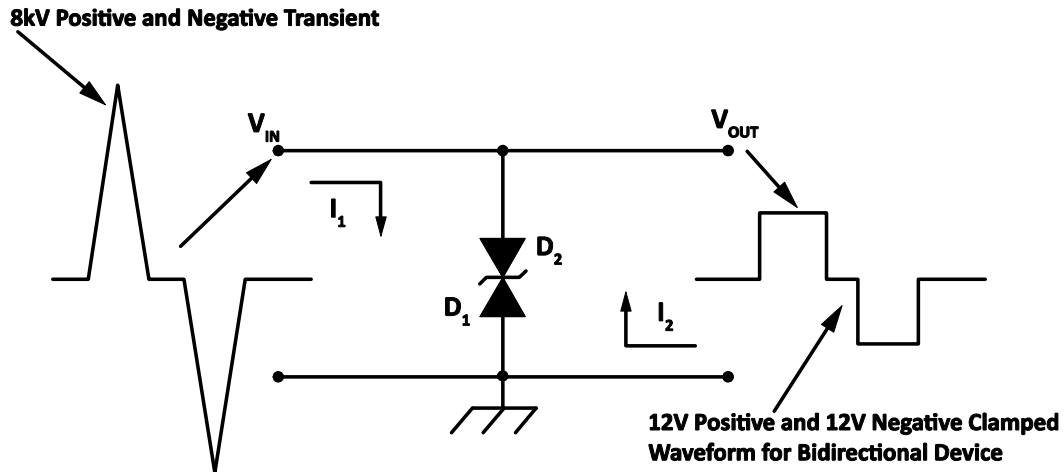

Bidirectional TVS



Avalanche Junction TVS VI Characteristics

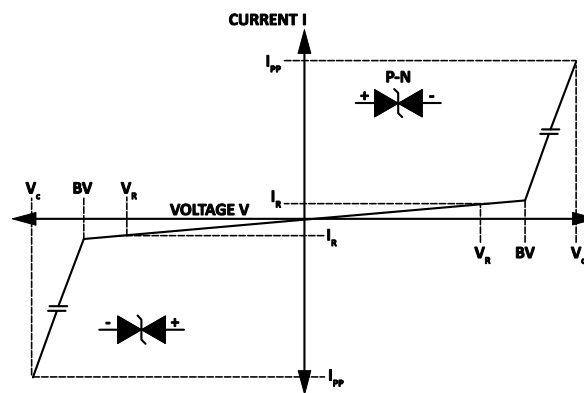

Symbol

B_V
 I_R
 V_R
 V_C
 I_{PP}

Parameter

Breakdown Voltage
 Leakage Current
 Reverse Stand-Off Voltage
 Clamping Voltage
 Peak Pulse Current

SELECTION PROCESS

TVS Parameters

Stand-Off Voltage (V_R) \geq
 Peak Pulse Current (I_P) \geq
 Clamping Voltage (V_C) \leq
 Input Capacitance of the Device \leq

Application Parameters

Operating Voltage (V_{OP})
 Transient Current (I_T)
 Voltage Withstand Level (V_{WS})
 Acceptable Line Loading for Functional Pass

AUTOMOTIVE APPLICATIONS

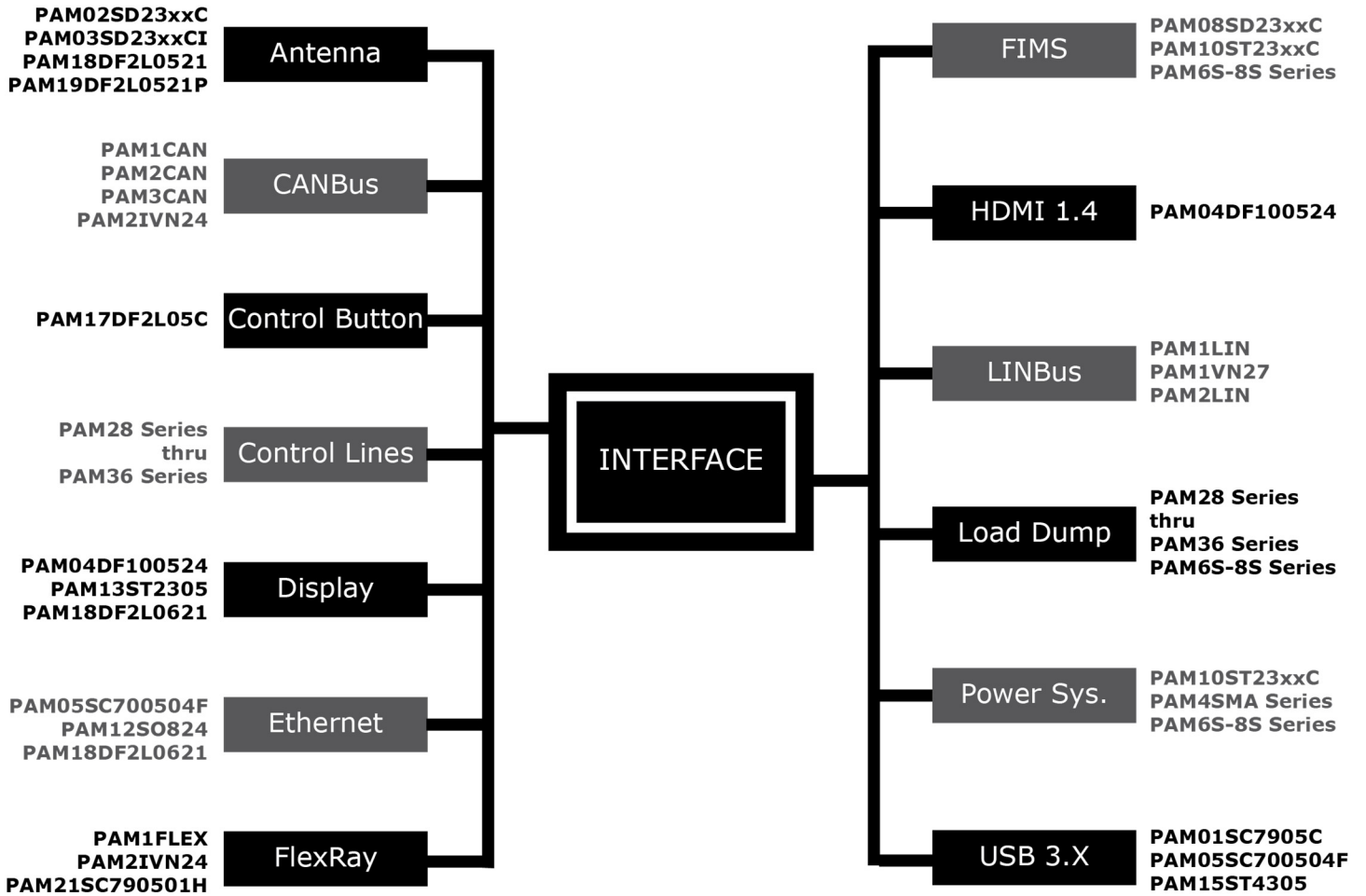

CONSUMER ELECTRONIC APPLICATIONS

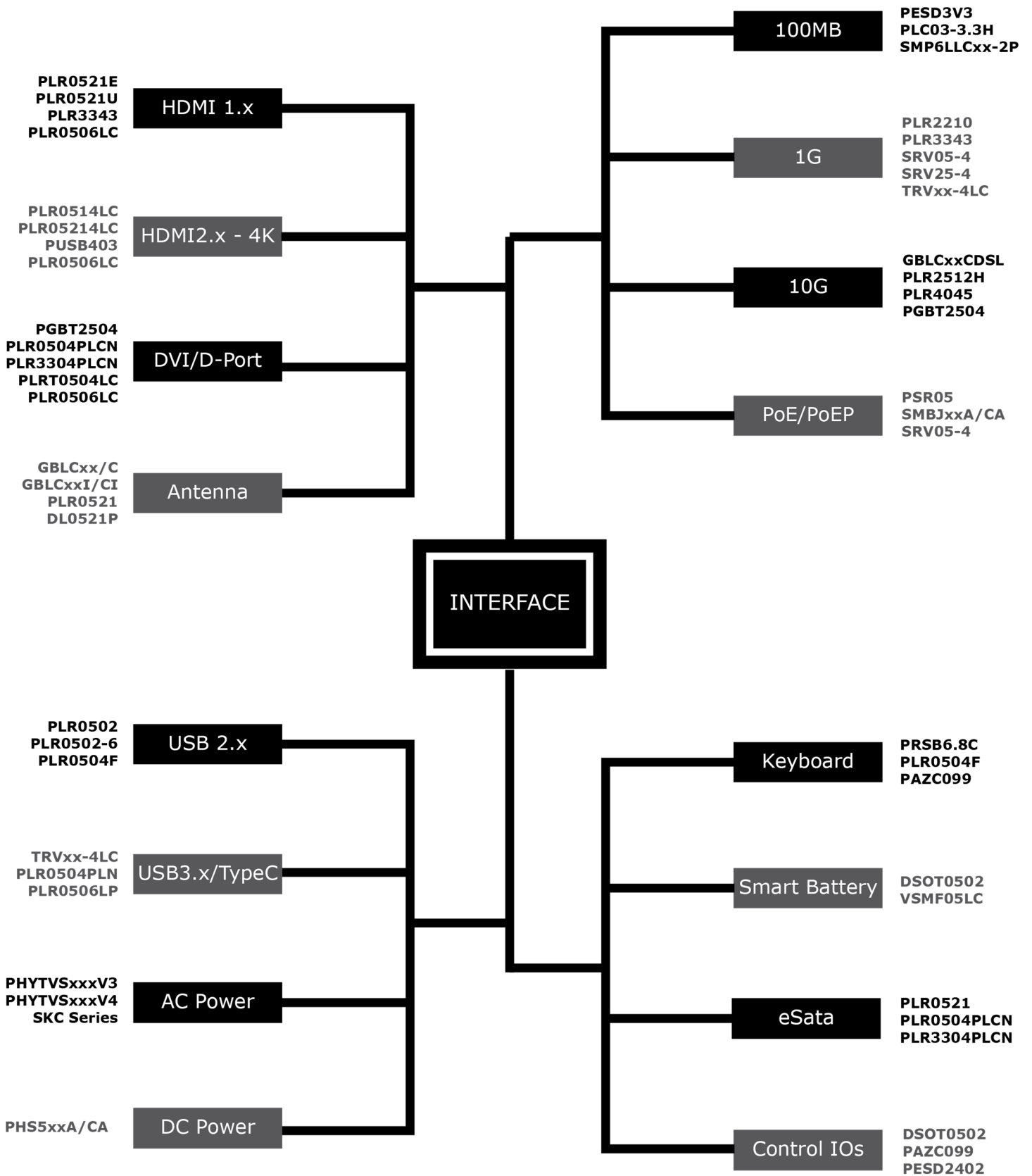

INDUSTRIAL APPLICATIONS

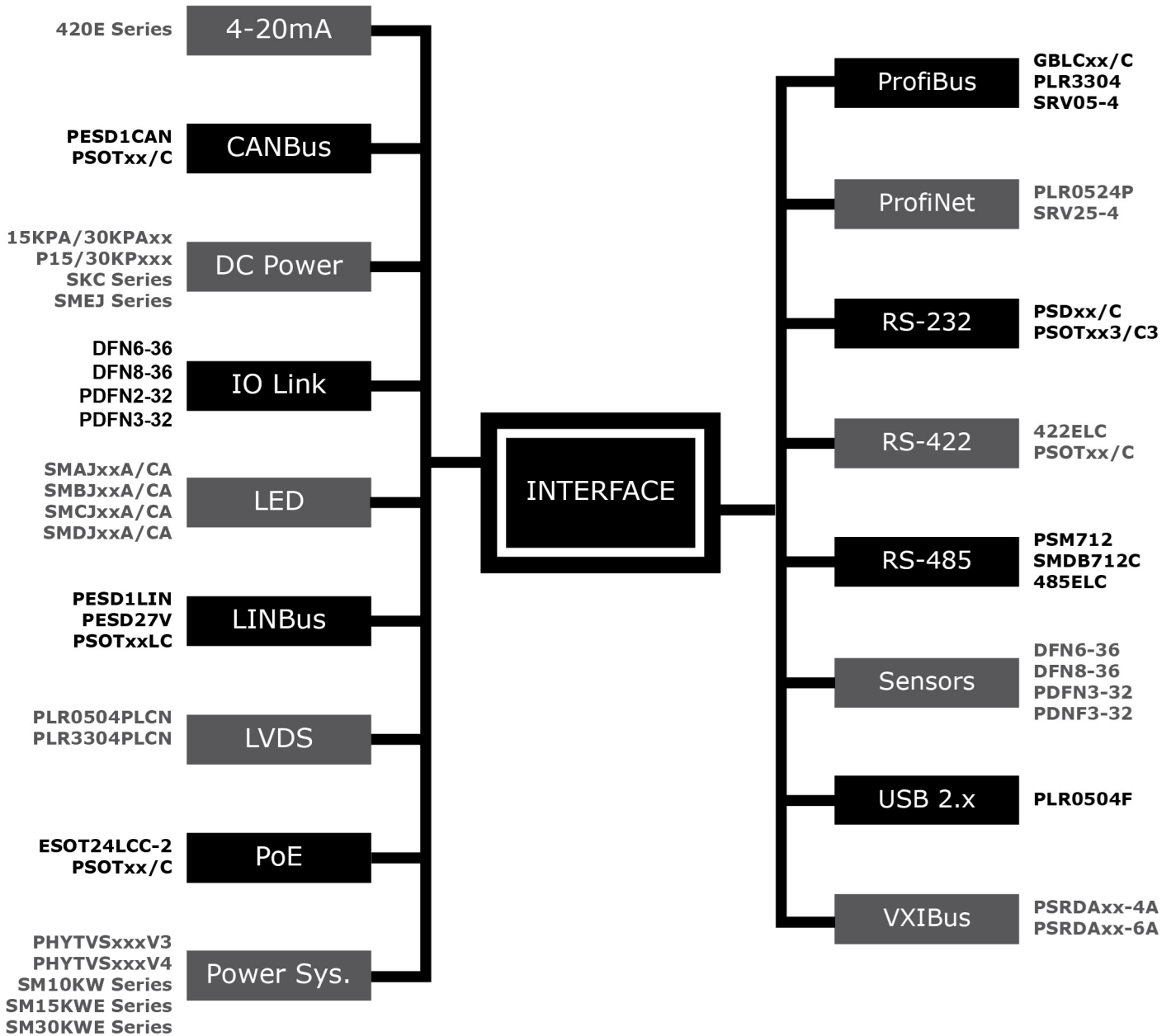

MILITARY/AEROSPACE APPLICATIONS

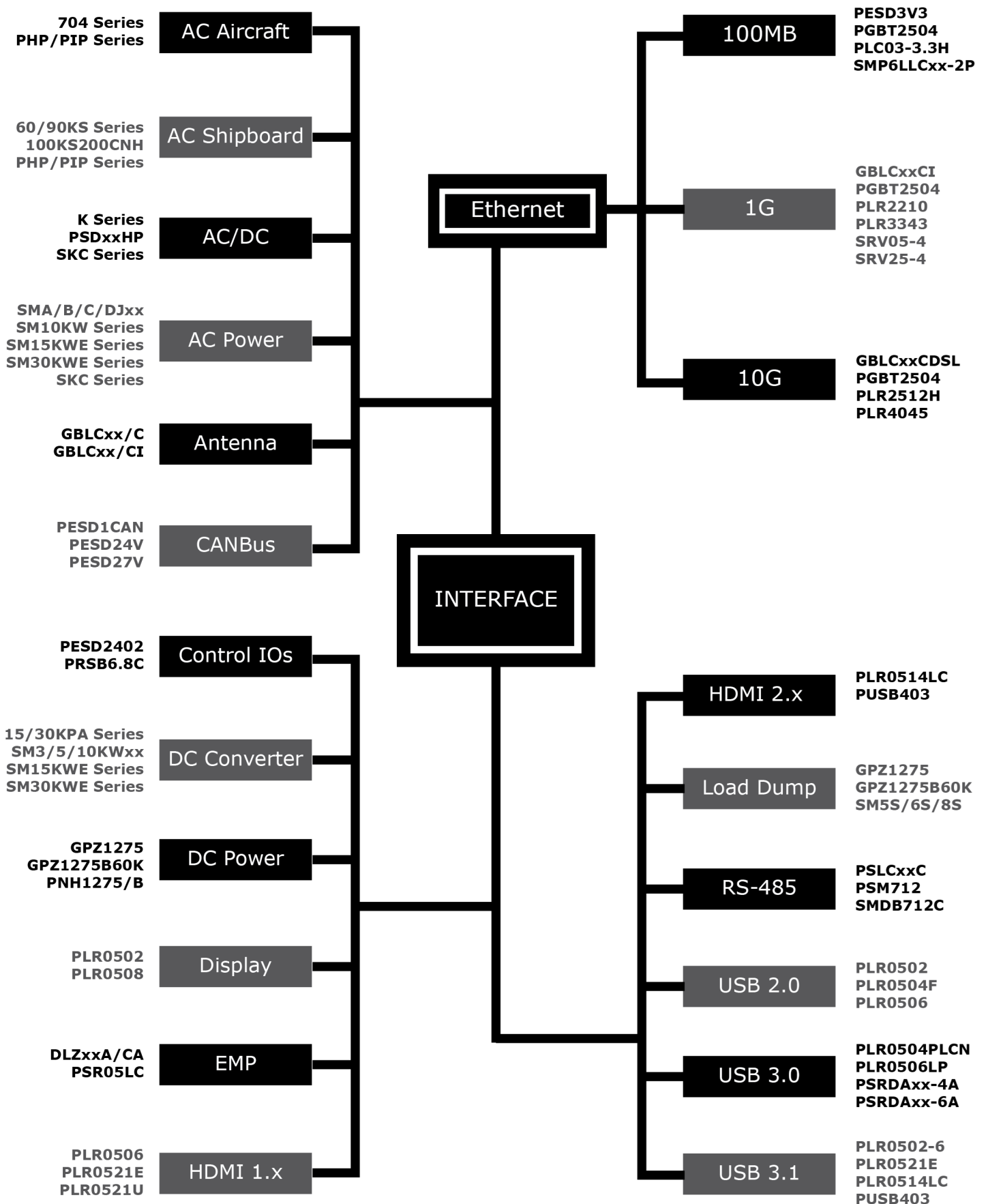

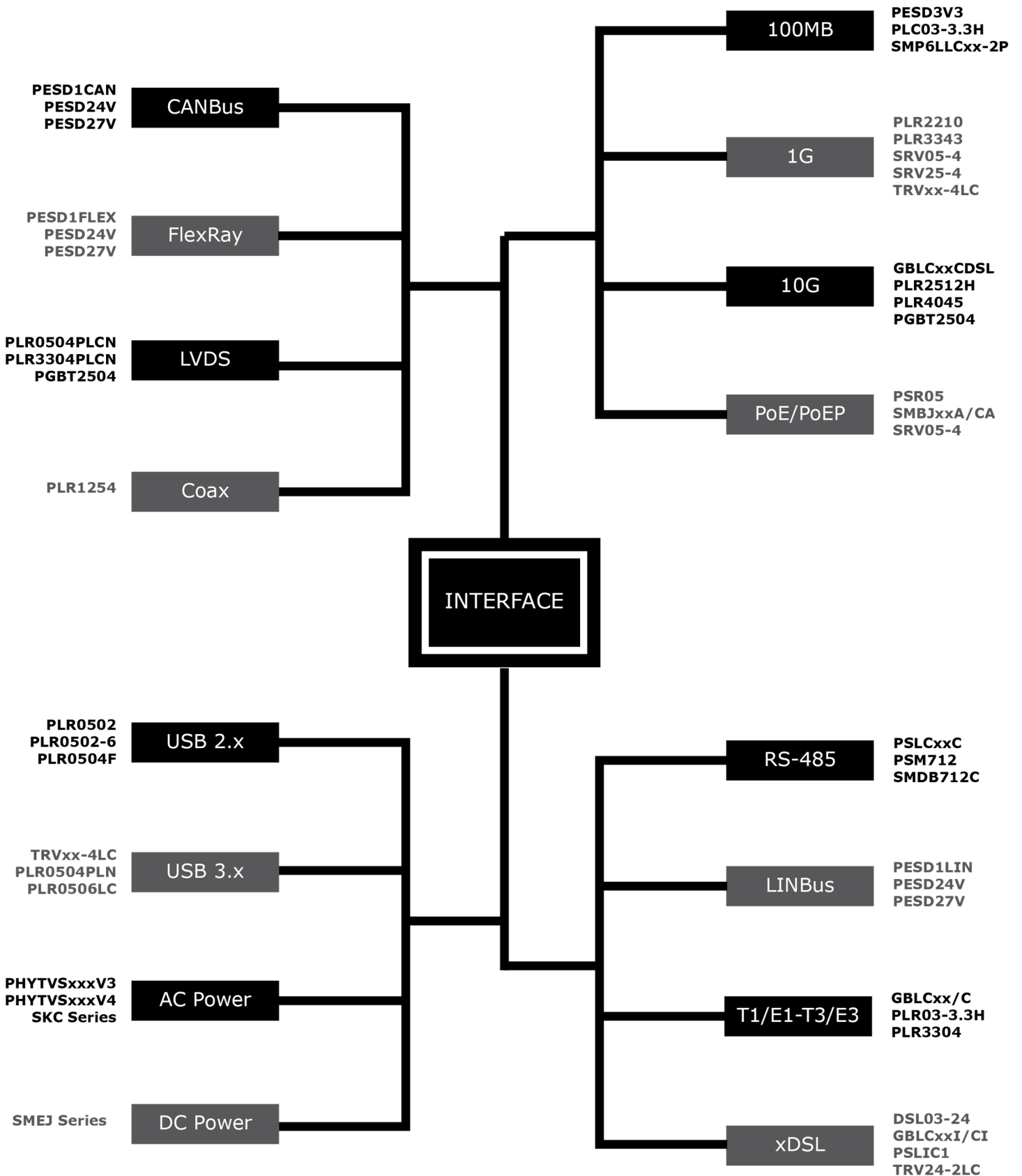

NETWORKING/TELECOM APPLICATIONS

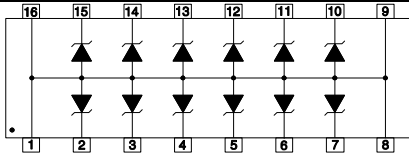
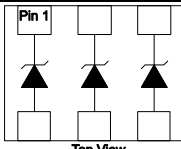
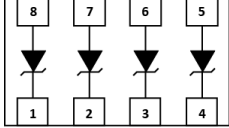
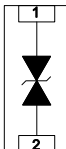
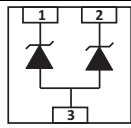
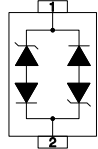
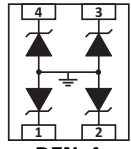
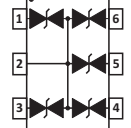
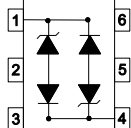

TVS DIODE ARRAYS									
PART NUMBER	STAND-OFF VOLTAGE - V_{WM}	MIN. BREAKDOWN VOLTAGE - V_{BR}	CLAMPING VOLTAGE - $V_C @ I_{PP}$	CURRENT I_{PP} @ 8/20 μ s - A	LEAKAGE CURRENT - μ A @ V_{WM}	CAPACITANCE C_j - pF	NUMBER OF LINES	POWER @ 8/20 μ s - WATTS	PIN CONFIGURATION
CP05	5.0	6.0	9.8	1.0	20	70	4-5	200	<p>SOT-23-6</p>
CP12	12.0	13.3	19.0	1.0	1	50	4-5	200	
CP15	15.0	16.7	24.0	1.0	1	30	4-5	200	
CP24	24.0	26.7	43.0	1.0	1	25	4-5	200	
Note: Part numbers shown are unidirectional. Add a "C" suffix to specify bidirectional devices, such as 'CP05C'.									
DA05CL	5.0	6.0	24.6	45.0	200	500	4	800	<p>8 PIN DIP</p>
DA12CL	12.0	13.3	32.9	34.0	2	385	4	800	
DA15CL	15.0	16.7	37.7	27.0	2	300	4	800	
DA24CL	24.0	26.7	53.0	20.0	2	200	4	800	
DA05CM	5.0	6.0	24.6	45.0	200	500	6	800	<p>8 PIN DIP</p>
DA12CM	12.0	13.3	32.9	34.0	2	385	6	800	
DA15CM	15.0	16.7	37.7	27.0	2	300	6	800	
DA24CM	24.0	26.7	53.0	20.0	2	200	6	800	
DA05CN	5.0	6.0	24.6	45.0	200	500	8	800	<p>16 PIN DIP</p>
DA12CN	12.0	13.3	32.9	34.0	2	385	8	800	
DA15CN	15.0	16.7	37.7	27.0	2	300	8	800	
DA24CN	24.0	26.7	53.0	20.0	2	200	8	800	
DA05CP	5.0	6.0	24.6	45.0	200	500	12	800	<p>16 PIN DIP</p>
DA12CP	12.0	13.3	32.9	34.0	2	385	12	800	
DA15CP	15.0	16.7	37.7	27.0	2	300	12	800	
DA24CP	24.0	26.7	53.0	20.0	2	200	12	800	
DA05L	5.0	6.0	24.6	45.0	200	880	4	800	<p>8 PIN DIP</p>
DA12L	12.0	13.3	32.9	34.0	2	440	4	800	
DA15L	15.0	16.7	37.7	27.0	2	400	4	800	
DA24L	24.0	26.7	53.0	20.0	2	275	4	800	
DA05M	5.0	6.0	24.6	45.0	200	880	6	800	<p>8 PIN DIP</p>
DA12M	12.0	13.3	32.9	34.0	2	440	6	800	
DA15M	15.0	16.7	37.7	27.0	2	400	6	800	
DA24M	24.0	26.7	53.0	20.0	2	275	6	800	
DA05N	5.0	6.0	24.6	45.0	200	880	8	800	<p>16 PIN DIP</p>
DA12N	12.0	13.3	32.9	34.0	2	440	8	800	
DA15N	15.0	16.7	37.7	27.0	2	400	8	800	
DA24N	24.0	26.7	53.0	20.0	2	275	8	800	

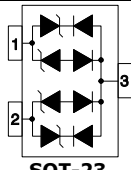
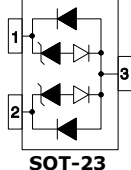
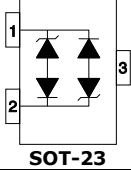
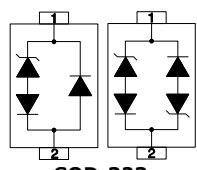
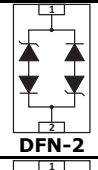
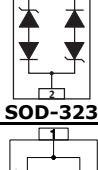
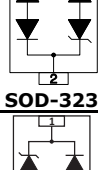
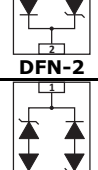
TVS DIODE ARRAYS									
PART NUMBER	STAND-OFF VOLTAGE - V_{WM}	MIN. BREAKDOWN VOLTAGE - V_{BR}	CLAMPING VOLTAGE - $V_C @ I_{PP}$	CURRENT I_{PP} @ 8/20 μ s - A	LEAKAGE CURRENT - μ A @ V_{WM}	CAPACITANCE C_j - pF	NUMBER OF LINES	POWER @ 8/20 μ s - WATTS	PIN CONFIGURATION
DA05P	5.0	6.0	24.6	45.0	200	880	12	800	 <p>16 PIN DIP</p>
DA12P	12.0	13.3	32.9	34.0	2	440	12	800	
DA15P	15.0	16.7	37.7	27.0	2	400	12	800	
DA24P	24.0	26.7	53.0	20.0	2	275	12	800	
DFN6-36	33.0	35.0	45.0	2.0	5	50	3	300	 <p>Top View DFN-6</p>
DFN8-36	33.0	35.0	45.0	2.0	5	50	4	300	 <p>Top View DFN-8</p>
DL0521P	5.0	6.0	20	1.0	1	0.6	1	20	 <p>DFN-2-0402</p>
DSOT0502	5.0	6.0	12.5	2.0	2	9	1	25	 <p>SOT-883</p>
EBLC05C	5.0	6.0	18.3	17.0	5	3	1	250	 <p>SOD-323</p>
EBLC08C	8.0	8.5	28.0	12.0	2	3	1	250	
EBLC12C	12.0	13.3	31.0	8.0	1	3	1	250	
ESD4-DFN	5.0	6.0	12.0	1.0	0.1 @ 3V	7 @ 2.5V	4	25	 <p>DFN-4</p>
ESDA05C-5	5.0	6.1	-	-	1	15	5	80	 <p>SOT-23-6</p>
ESOT12LCC-1	12.0	13.3	19.0	1.0	1	3	2	250	 <p>SOT-23-6</p>

TVS DIODE ARRAYS									
PART NUMBER	STAND-OFF VOLTAGE - V_{WM}	MIN. BREAKDOWN VOLTAGE - V_{BR}	CLAMPING VOLTAGE - $V_C @ I_{PP}$	CURRENT I_{PP} @ 8/20 μ s - A	LEAKAGE CURRENT - μ A @ V_{WM}	CAPACITANCE C_j - pF	NUMBER OF LINES	POWER @ 8/20 μ s - WATTS	PIN CONFIGURATION
ESOT24LCC-2	24.0	26.6	-	-	1	6	2	100	 SOT-23
ESOT3.3LC-2	3.3	3.5	6.5	1.0	2	15	2	175	 SOT-23
ESOT3.3LCC	3.3	3.6	-	-	2	15	1	50	 SOT-23
GBLC03	3.3	4.0	7.0	1.0	5	3	1	350	 SOD-323
GBLC05	5.0	6.0	9.8	1.0	5	3	1	350	
GBLC08	8.0	8.5	13.4	1.0	2	3	1	350	
GBLC12	12.0	13.3	19.0	1.0	1	3	1	350	
GBLC15	15.0	16.7	24.0	1.0	1	3	1	350	
GBLC18	18.0	20.0	29.0	1.0	1	3	1	350	
GBLC24	24.0	26.7	43.0	1.0	1	3	1	350	
Note: Part numbers shown are unidirectional. Add a "C" suffix to specify bidirectional devices, such as 'GBLC05C'.									
GBLC05CDN	5.0	6.0	18.3	17.0	5	3	1	350	 DFN-2
GBLC08CDN	8.0	8.5	18.5	17.0	2	3	1	350	
GBLC12CDN	12.0	13.3	26.5	11.0	1	3	1	350	
GBLC15CDN	15.0	16.7	31.8	10.0	1	3	1	350	
GBLC24CDN	24.0	26.7	56.0	6.0	1	3	1	350	
GBLC12CDSL	12.0	13.3	19.0	1.0	1	3	1	350	 SOD-323
GBLC24CDSL	24.0	26.7	43.0	1.0	1	3	1	350	
GBLC15CDSL	15.0	16.7	24.0	1.0	1	3	1	350	 SOD-323
GBLC03CIDFN	3.0	4.0	7.0	1.0	1	0.6	1	250	 DFN-2
GBLC05CIDFN	5.0	6.1	8.0	1.0	5	0.6	1	250	
GBLC03CIDNHP	3.0	4.0	24.0	20.0	5	0.6	1	500	 DFN-2

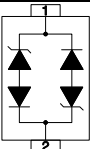
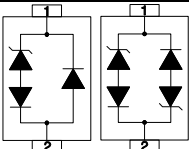
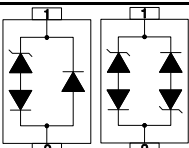
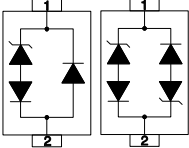
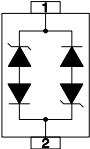
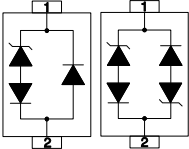
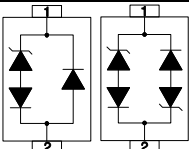
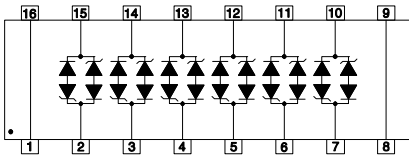
TVS DIODE ARRAYS									
PART NUMBER	STAND-OFF VOLTAGE - V_{WM}	MIN. BREAKDOWN VOLTAGE - V_{BR}	CLAMPING VOLTAGE - $V_C @ I_{PP}$	CURRENT I_{PP} @ 8/20 μ s - A	LEAKAGE CURRENT - μ A @ V_{WM}	CAPACITANCE C_j - pF	NUMBER OF LINES	POWER @ 8/20 μ s - WATTS	PIN CONFIGURATION
GBLC03CIHP	3.0	4.0	24.0	20.0	5	0.6	1	500	 SOD-323
GBLC03HP	3.3	4.0	9.5	1.0	0.5	3	1	750	 SOD-323
GBLC05HP	5.0	6.0	10.5	1.0	0.5	3	1	750	
Note: Part numbers shown are unidirectional. Add a "C" suffix to specify bidirectional devices, such as 'GBLC05CHP'.									
GBLC03I	3.0	4.0	7.0	1.0	5	0.6	1	250	 SOD-323
GBLC05I	5.0	6.0	9.8	1.0	5	0.6	1	250	
GBLC08I	8.0	8.5	13.4	1.0	2	0.6	1	250	
GBLC12I	12.0	13.3	19.0	1.0	1	0.6	1	250	
GBLC15I	15.0	16.7	24.0	1.0	1	0.6	1	250	
GBLC18I	18.0	20.0	29.0	1.0	1	0.6	1	250	
GBLC24I	24.0	26.7	43.0	1.0	1	0.6	1	250	
Note: Part numbers shown are unidirectional. Add a "C" suffix to specify bidirectional devices, such as 'GBLC05CI'.									
GBLC03LC	3.3	4.0	7.0	1.0	1	0.8	1	250	 SOD-323
GBLC05LC	5.0	6.0	9.8	1.0	5	0.7	1	250	
Note: Part numbers shown are unidirectional. Add a "C" suffix to specify bidirectional devices, such as 'GBLC05CLC'.									
GBLCSC08CLC	8.0	8.5	13.0	1.0	1	0.4	1	125	 SC-79
GBLCSC03	3.3	4.0	13.0	10.0	1	1.5	1	200	 SC-79
GBLCSC05	5.0	6.0	16.0	10.0	1	1.5	1	200	
GBLCSC08	8.0	8.5	-	-	1	1.5	1	200	
GBLCSC12	12.0	13.3	-	-	1	1.5	1	200	
Note: Part numbers shown are unidirectional. Add a "C" suffix to specify bidirectional devices, such as 'GBLCSC05C'.									
GBLLC03	3.0	4.0	7.0	1.0	1	0.4	1	200	 SOD-323
Note: Part numbers shown are unidirectional. Add a "C" suffix to specify bidirectional devices, such as 'GBLLC03C'.									
LCA05C	5.0	6.0	24.0	45.0	100	15	6	800	 16 PIN DIP
LCA08C	8.0	8.5	25.5	40.0	10	15	6	800	
LCA12C	12.0	13.3	32.0	34.0	4	15	6	800	
LCA15C	15.0	16.7	38.0	27.0	4	15	6	800	
LCA24C	24.0	26.7	48.0	22.0	4	15	6	800	

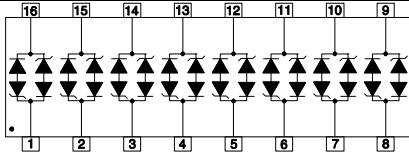
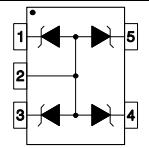
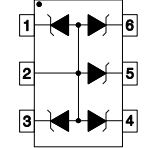
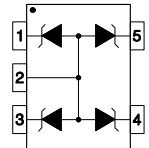
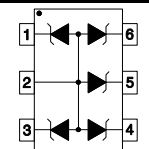
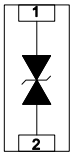
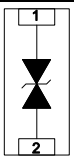
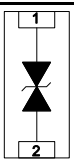
TVS DIODE ARRAYS									
PART NUMBER	STAND-OFF VOLTAGE - V_{WM}	MIN. BREAKDOWN VOLTAGE - V_{BR}	CLAMPING VOLTAGE - $V_c @ I_{PP}$	CURRENT I_{PP} @ 8/20 μ s - A	LEAKAGE CURRENT - μ A @ V_{WM}	CAPACITANCE C_j - pF	NUMBER OF LINES	POWER @ 8/20 μ s - WATTS	PIN CONFIGURATION
LCD05C	5.0	6.0	24.0	45.0	100	15	8	800	 <p>16 PIN DIP</p>
LCD08C	8.0	8.5	25.5	40.0	10	15	8	800	
LCD12C	12.0	13.3	32.0	34.0	4	15	8	800	
LCD15C	15.0	16.7	38.0	27.0	4	15	8	800	
LCD24C	24.0	26.7	48.0	22.0	4	15	8	800	
MSMF05	5.0	6.0	12.0	9.0	1	40	3-4	100	 <p>SOT-553</p>
MSMF12	12.0	13.3	23.8	4.2	1	20	3-4	100	
MSMF15	15.0	16.7	33.3	3.0	1	15	3-4	100	
MSMF24	24.0	26.7	55.5	1.8	1	10	3-4	100	
MSMF05C	5.0	6.0	12.0	9.0	1	40	4-5	100	 <p>SOT-563</p>
MSMF12C	12.0	13.3	23.8	4.2	1	20	4-5	100	
MSMF15C	15.0	16.7	33.3	3.0	1	15	4-5	100	
MSMF24C	24.0	26.7	55.5	1.8	1	10	4-5	100	
MSMF05LC	5.0	6.0	12.0	2.0	1	9	3-4	25	 <p>SOT-553</p>
Note: Also available in SOT-953 package configuration, part number VSMF05LC									
MSMF05LCC	5.0	6.0	12.0	2	1	9	4-5	25	 <p>SOT-563</p>
Note: Also available in SOT-963 package configuration, part number VSMF05LCC									
P0201D05C	4.7	5.7	16.0	1.0	0.1	5	1	10	 <p>DFN-2-0201</p>
P0402V05	5.0	-	35.0	-	0.10	0.15	1	-	 <p>CERAMIC-0402</p>
P0402V15	15.0	-	35.0	-	0.10	0.05	1	-	
P0402VP24	24.0	-	20.0	-	0.10	0.05	1	-	 <p>CERAMIC-0402</p>

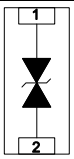
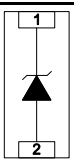
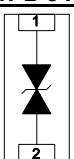
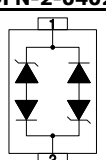
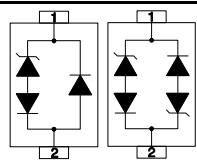
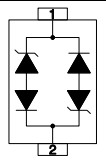
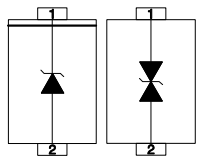
TVS DIODE ARRAYS									
PART NUMBER	STAND-OFF VOLTAGE - V_{WM}	MIN. BREAKDOWN VOLTAGE - V_{BR}	CLAMPING VOLTAGE - $V_C @ I_{PP}$	CURRENT I_{PP} @ 8/20 μ s - A	LEAKAGE CURRENT - μ A @ V_{WM}	CAPACITANCE C_j - pF	NUMBER OF LINES	POWER @ 8/20 μ s - WATTS	PIN CONFIGURATION
P0603V24	24.0	-	35.0	-	0.10	0.05	1	-	 0603
P5V0S1UL	5.0	6.0	9.8	1.0	1	70	1	150	 DFN-2-0402
P5V0S1ULC	5.0	6.0	9.8	1.0	1	30	1	110	 DFN-2-0402
PAM01SC7905C	5.0	6.0	16.0	10.0	1	1.5	1	200	 SC-79
PAM02SD2303	3.3	4.0	7.0	1.0	5	3	1	350	 SOD-323
PAM02SD2305	5.0	6.0	9.8	1.0	5	3	1	350	
PAM02SD2308	8.0	8.5	13.4	1.0	2	3	1	350	
PAM02SD2312	12.0	13.3	19.0	1.0	1	3	1	350	
PAM02SD2318	18.0	20.0	29.0	1.0	1	3	1	350	
PAM02SD2324	24.0	26.7	43.0	1.0	1	3	1	350	
Note: Part numbers shown are unidirectional. Add a "C" suffix to specify bidirectional devices, such as 'PAM02SD2305C'.									
PAM03SD2303CI	3.0	4.0	7.0	1.0	5	0.6	1	250	 SOD-323
PAM03SD2305CI	5.0	6.0	9.8	1.0	5	0.6	1	250	
PAM03SD2312CI	12.0	13.3	19.0	1.0	1	0.6	1	250	
PAM03SD2318CI	18.0	20.0	29.0	1.0	1	0.6	1	250	
PAM03SD2324CI	24.0	26.7	43.0	1.0	1	0.6	1	250	
PAM08SD2303	3.3	4.0	6.5	1.0	125	500	1	500	 SOD-323
PAM08SD2303C	3.3	4.0	7.0	1.0	125	200	1	400	
PAM08SD2305	5.0	6.0	9.8	1.0	10	350	1	400	
PAM08SD2305C	5.0	6.0	9.8	1.0	10	175	1	400	
PAM05SD2308C	8.0	8.5	13.4	1.0	10	150	1	400	
PAM08SD2312C	12.0	13.3	19.0	1.0	1	50	1	400	
PAM08SD2315	15.0	16.7	24.0	1.0	1	100	1	500	
PAM08SD2324C	24.0	26.7	43.0	1.0	1	40	1	400	
PAM08SD2336C	36.0	40.0	60.0	1.0	1	35	1	400	
PAM10ST2303C	3.3	4.0	10.9	43.0	125	300	1	500	
PAM10ST2305C	5.0	6.0	13.5	42.0	20	210	1	500	
PAM10ST2308C	8.0	8.5	16.9	34.0	10	150	1	500	
PAM10ST2312C	12.0	13.3	25.9	21.0	2	90	1	500	
PAM10ST2315C	15.0	16.7	30.0	17.0	1	60	1	500	
PAM10ST2324C	24.0	26.7	49.0	12.0	1	63	1	500	
PAM10ST2336C	36.0	40.0	76.8	9.0	1	60	1	500	

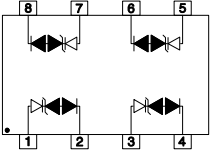
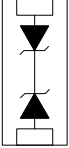
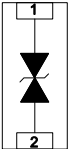
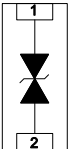
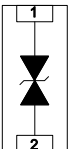
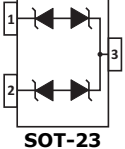
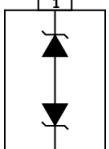
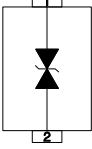
TVS DIODE ARRAYS									
PART NUMBER	STAND-OFF VOLTAGE - V_{WM}	MIN. BREAKDOWN VOLTAGE - V_{BR}	CLAMPING VOLTAGE - $V_C @ I_{PP}$	CURRENT I_{PP} @ 8/20 μ s - A	LEAKAGE CURRENT - μ A @ V_{WM}	CAPACITANCE C_j - pF	NUMBER OF LINES	POWER @ 8/20 μ s - WATTS	PIN CONFIGURATION
PAM12SO824	2.8	3.0	21.0	30.0	1	3	2P	600	 SO-8
PAM17DF2L05C	4.7	5.7	-	-	1	15	1	10	 DFN-2-0402
Note: I_{PP} and P_{PP} at 10/1000 μ s.									
PAM18DF2L0521	5.0	6.0	20.0	3.0	1	0.4	1	80	 DFN-2-0402
PAM18DF2L0621	5.5	6.1	18.0	3.0	0.1	0.4	1	80	 DFN-2-0402
PAM19DF2L0521P	5.0	6.0	20.0	1.0	1	0.6	1	20	 DFN-2-0402
PAM1CAN	24.0	25.4	70.0	3.0	0.05	11	2	200	 SOT-23
PAM1FLEX	24.0	25.4	70.0	3.0	0.05	11	2	200	
PAM11VN27	27.0	28.0	45.0	3.0	0.8	15	1	135	 SOD-323
PAM1LIN PIN 1 - 2	15.0	17.2	44.0	5.0	0.045	17	1	200	 SOD-323
PIN 2 - 1	24.0	25.5	70.0	3.0	0.045	17	1	200	

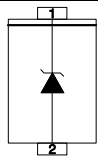
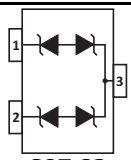
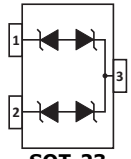
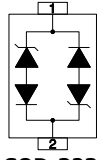
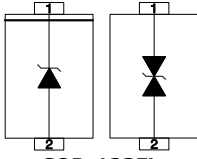
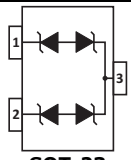
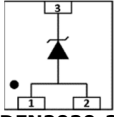
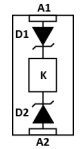
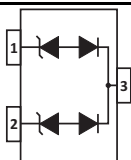

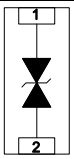
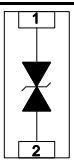
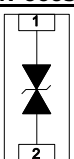
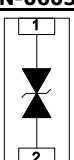
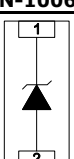
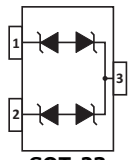
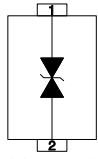
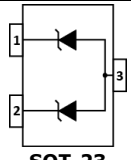
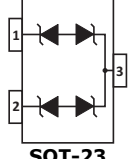

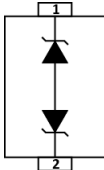
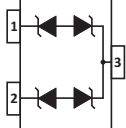
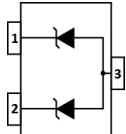
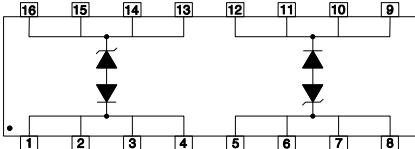
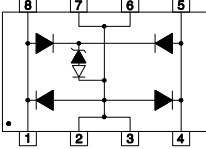
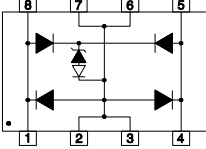
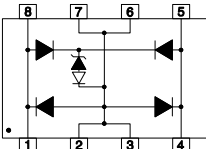
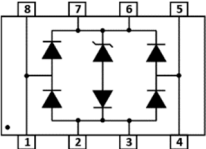
TVS DIODE ARRAYS									
PART NUMBER	STAND-OFF VOLTAGE - V_{WM}	MIN. BREAKDOWN VOLTAGE - $V_{(BR)}$	CLAMPING VOLTAGE - $V_c @ I_{PP}$	CURRENT I_{PP} @ 8/20 μ s - A	LEAKAGE CURRENT - μ A @ V_{WM}	CAPACITANCE C_j - pF	NUMBER OF LINES	POWER @ 8/20 μ s - WATTS	PIN CONFIGURATION
PAM21SC790501H	5.0	6.0	12.5	16.0	5	120	1	250	 SC-79
PAM2CAN	24.0	25.4	60.0	4.0	0.05	11	2	230	 SOT-23
PAM2IVN24	24.0	25.5	42.0	3.5	10	20	2	150	 SOT-23
PAM2LIN	24.0	26.7	43.0	1.0	0.001	3	2	200	 SOD-323
PAM37SD6.0AL	6.0	6.67	10.3	35.9	120	-	1	400	 SOD-123FL
Not all voltages are shown for the PAM37SDxxAL Series. Please consult the factory for other voltages.									
PAM37SD58AL	58.0	64.4	93.6	4.3	1	-	1	400	
Note: I_{PP} and P_{PP} @ 10/1000 μ s. Part numbers shown are unidirectional. Add a "C" suffix to specify bidirectional device, such as 'PAM37SD12CAL'.									
PAM3CAN	24.0	25.4	70.0	2.1	0.002	5	2	150	 SOT-23
PDFN2-32	32.0	34.0	55.0	25.0	5	-	1	1400	 DFN2020-3
PDFN3-32	32.0	34.0	55.0	25.0	0.2	-	1	2800	 DFN-3
PDLC05	5.0	6.0	9.8	1.0	5	0.8	1	-	 SOT-23

TVS DIODE ARRAYS									
PART NUMBER	STAND-OFF VOLTAGE - V_{WM}	MIN. BREAKDOWN VOLTAGE - V_{BR}	CLAMPING VOLTAGE - $V_C @ I_{PP}$	CURRENT I_{PP} @ 8/20 μ s - A	LEAKAGE CURRENT - μ A @ V_{WM}	CAPACITANCE C_j - pF	NUMBER OF LINES	POWER @ 8/20 μ s - WATTS	PIN CONFIGURATION
PESD05B	5.0	5.6	9.5	4.0	1	10	1	40	 DFN-0603-2
PESD05BLC	5.0	7.0	9.5	3.0	1	0.42	1	40	 DFN-0603-2
PESD05BULC	5.0	5.5	9.5	10.0	0.95	0.35	1	60	 DFN-0603-2
PESD12LCB	12.0	14.0	27	4	1	8	1	90	 DFN-1006-2
PESD12ULC	12.0	14.5	23	3.5	1	15.5	1	70	 DFN-0603-2
PESD1CAN	24.0	25.4	70.0	3.0	0.05	11	2	200	 SOT-23
PESD1FLEX	24.0	25.4	70.0	3.0	0.05	11	2	200	
PESD1LIN PIN 1 - 2	15.0	17.2	44.0	5.0	0.045	17	1	200	 SOD-323
PIN 2 - 1	24.0	25.5	70.0	3.0	0.045	17	1	200	
PESD2402	24.0	25.4	-	-	0.5	22	2	100	 SOT-23
PESD24V	24.0	25.5	42.0	3.5	0.8	20	1	150	 SOT-23

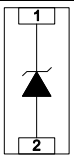
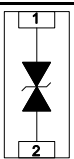
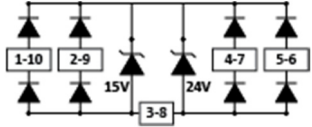
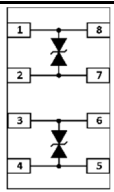
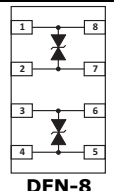
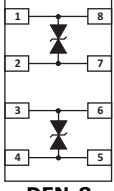
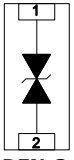
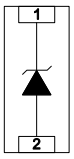
TVS DIODE ARRAYS									
PART NUMBER	STAND-OFF VOLTAGE - V_{WM}	MIN. BREAKDOWN VOLTAGE - V_{BR}	CLAMPING VOLTAGE - $V_C @ I_{PP}$	CURRENT I_{PP} @ 8/20 μ s - A	LEAKAGE CURRENT - μ A @ V_{WM}	CAPACITANCE C_j - pF	NUMBER OF LINES	POWER @ 8/20 μ s - WATTS	PIN CONFIGURATION
PESD27V	27.0	28.0	45.0	3.0	0.10	15	1	135	 SOD-323
PESD2CAN	24.0	25.4	60.0	4.0	0.05	11	2	230	 SOT-23
PESD3V3	3.3	5.2	20.0	20.0	2	20	1	400	 SOD-323
PLC01-6	6.0	8.0	16.0	200.0	25	50	1	1500	 SO-16(WIDE BODY)
Note: I_{PP} & P_{PP} @ 10/1000 μ s									
PLC03-3.3	3.0	2.8	22.0	150.0	2	25	1	3300	 SO-8
PLC03-3.3-DFN	3.0	2.8	18.0	100.0	2	25	1	1800	 DFN-6
PLC03-3.3H	3.0	2.8	25.0	240.0	2	25	1	6000	 SO-8
PLC03-3.3V	3.0	2.8	22.0	150.0	2	25	4	3300	 SO-8

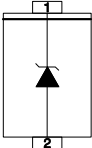
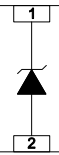
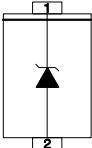
TVS DIODE ARRAYS									
PART NUMBER	STAND-OFF VOLTAGE - V_{WM}	MIN. BREAKDOWN VOLTAGE - V_{BR}	CLAMPING VOLTAGE - $V_C @ I_{PP}$	CURRENT I_{PP} @ 8/20 μ s - A	LEAKAGE CURRENT - μ A @ V_{WM}	CAPACITANCE C_j - pF	NUMBER OF LINES	POWER @ 8/20 μ s - WATTS	PIN CONFIGURATION
PLC03-3.3LC	3.0	2.8	18.0	100.0	2	6	1	1800	<p>SO-8</p>
PLC03-6LC	6.0	6.8	20.0	90.0	2.5	6	1	1800	
PLC496	1.0	2.5	12.5	30.0	1	1.25	1	500	<p>SO-8</p>
PLCDA03	3.3	4.5	7.0	1.0	125	5	2	500	<p>SO-8</p>
PLCDA05	5.0	6.0	9.8	1.0	20	5	2	500	
PLCDA08	8.0	8.5	13.4	1.0	10	5	2	500	
PLCDA12	12.0	13.3	19.0	1.0	1	5	2	500	
PLCDA15	15.0	16.7	24.0	1.0	1	5	2	500	
PLCDA24	24.0	26.7	43.0	1.0	1	5	2	500	
PLCDA03C-6	3.3	4.5	7.0	1.0	125	8	6	500	<p>SO-8</p>
PLCDA05C-6	5.0	6.0	9.8	1.0	20	8	6	500	
PLCDA08C-6	8.0	8.5	13.4	1.0	10	8	6	500	
PLCDA12C-6	12.0	13.3	19.0	1.0	2	8	6	500	
PLCDA15C-6	15.0	16.7	24.0	1.0	2	8	6	500	
PLR0503	5.0	6.0	12.5	2.0	1	9	1	25	<p>SOT-143</p>
PLR0521	5.0	6.0	20.0	4.0	1	0.4	1	80	<p>DFN-2-0402</p>
PLR05214LC	5.0	6.0	13.0	1.0	0.5	0.35	4	100	<p>DFN-10</p>
PLR0521E	5.0	6.0	20.0	4.0	1	0.4	1	80	<p>DFN-2-0402</p>

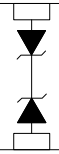
TVS DIODE ARRAYS									
PART NUMBER	STAND-OFF VOLTAGE - V_{WM}	MIN. BREAKDOWN VOLTAGE - V_{BR}	CLAMPING VOLTAGE - $V_C @ I_{PP}$	CURRENT I_{PP} @ 8/20 μ s - A	LEAKAGE CURRENT - μ A @ V_{WM}	CAPACITANCE C_j - pF	NUMBER OF LINES	POWER @ 8/20 μ s - WATTS	PIN CONFIGURATION
PLR0521U	5.0	6.0	20.0	4.0	1	0.8	1	80	 DFN-2-0402
PLR0621	5.5	6.1	14.0	1.0	0.1	0.4	1	80	 DFN-2-0402
PLR1524	15.0 24.0	16.7 16.7	35.0 50.0	1.0 1.0	0.1	1.2	4	60	 DFN-10
PLR2210	2.5	2.7	6.0	2.0	0.05	0.6	2	170	 DFN-8
PLR2512H	2.5	2.7	8.0	10.0	0.05	3	2P	100	 DFN-8
PLR2512	2.5	2.7	10.2	10.0	0.05	3	2P	100	 DFN-8
PLR3312	3.3	3.5	11.0	10.0	0.05	3	2P	100	
PLR3311	3.3	3.3	8.0	5.0	0.05	5	1	40	 DFN-2
PLW0501D	5.0	6.0	9.8	1.0	1	70	1	150	 DFN-2-0402

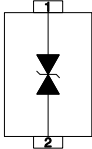
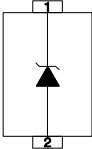
TVS DIODE ARRAYS									
PART NUMBER	STAND-OFF VOLTAGE - V_{WM}	MIN. BREAKDOWN VOLTAGE - V_{BR}	CLAMPING VOLTAGE - $V_C @ I_{PP}$	CURRENT I_{PP} @ 8/20 μ s - A	LEAKAGE CURRENT - μ A @ V_{WM}	CAPACITANCE C_j - pF	NUMBER OF LINES	POWER @ 8/20 μ s - WATTS	PIN CONFIGURATION
PLW0501H	5.0	6.0	12.5	16.0	5	120	1	250	 SC-79
PLW0501P	5.0	6.0	12.5	16.0	5	120	1	250	 DFN-2-0402
PLW1201H	12.0	13.3	24.0	5.0	1	50	1	200	 SC-79
PLW2.8	2.8	3.0	5.0	1.0	1	6	1	50	 SC-79
PRSB6.8C	4.7	5.7	17.5	3.0	0.5	15	1	50	 DFN-2-0402
PRSB6.8CT	4.7	5.7	-	-	1	15	1	10	 DFN-2-0402
Note: I_{PP} & P_{PP} @ 10/1000μs.									
PRSB6.8D	4.7	5.7	-	-	1	15	1	10	 SOD-923
Note: I_{PP} & P_{PP} @ 10/1000μs.									
PSD03	3.3	4.0	6.5	1.0	125	500	1	500	 SOD-323
PSD05	5.0	6.0	9.8	1.0	10	350	1	500	
PSD08	8.0	8.5	13.4	1.0	10	250	1	500	
PSD12	12.0	13.3	19.0	1.0	1	150	1	500	
PSD15	15.0	16.7	24.0	1.0	1	100	1	500	
PSD18	18.0	20.0	29.0	1.0	1	90	1	500	
PSD24	24.0	26.7	43.0	1.0	1	88	1	500	
PSD36	36.0	40.0	60.0	1.0	1	75	1	500	

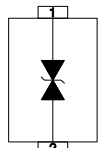
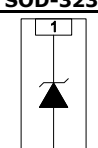
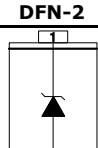
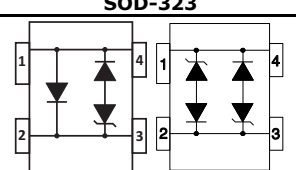
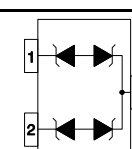
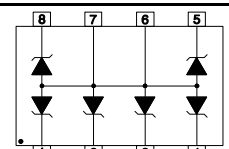
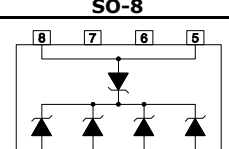
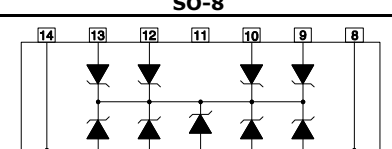
TVS DIODE ARRAYS									
PART NUMBER	STAND-OFF VOLTAGE - V_{WM}	MIN. BREAKDOWN VOLTAGE - V_{BR}	CLAMPING VOLTAGE - $V_C @ I_{PP}$	CURRENT I_{PP} @ 8/20 μ s - A	LEAKAGE CURRENT - μ A @ V_{WM}	CAPACITANCE C_j - pF	NUMBER OF LINES	POWER @ 8/20 μ s - WATTS	PIN CONFIGURATION
PSD03C	3.3	4.0	7.0	1.0	125	200	1	400	 <p>SOD-323</p>
PSD05C	5.0	6.0	9.8	1.0	10	175	1	400	
PSD08C	8.0	8.5	13.4	1.0	10	150	1	400	
PSD12C	12.0	13.3	19.0	1.0	1	50	1	400	
PSD15C	15.0	16.7	24.0	1.0	1	40	1	400	
PSD18C	18.0	20.0	29.0	1.0	1	40	1	400	
PSD24C	24.0	26.7	43.0	1.0	1	40	1	400	
PSD36C	36.0	40.0	60.0	1.0	1	35	1	400	
PSD0561	5.0	6.0	16.0	90.0	0.3	800	1	1400	 <p>DFN-2</p>
PSD3261	32.0	34.0	60.0	25.0	0.2	300	1	1400	
PSD05HP	5.0	6.0	15.0	72.0	20	800	1	1000	 <p>SOD-323</p>
PSD10HP	10.0	11.0	25.0	45.0	2	500	1	1000	
PSD12HP	12.0	13.3	32.0	34.0	2	440	1	1000	
PSLC03	3.3	4.0	19.0	20.0	125	3	1	350	 <p>SOT-143</p>
PSLC05	5.0	6.0	18.3	17.0	20	3	1	350	
PSLC08	8.0	8.5	18.5	17.0	10	3	1	350	
PSLC12	12.0	13.3	28.6	11.0	1	3	1	350	
PSLC15	15.0	16.6	31.8	10.0	1	3	1	350	
PSLC24	24.0	26.7	56.0	6.0	1	3	1	350	
Note: Part numbers shown are unidirectional. Add a "C" suffix to specify bidirectional devices, such as 'PSLC05C'.									
PSM712 Pin 3-1, 3-2 Pin 1-3, 2-3	7.0 12.0	7.5 13.3	17.0 30.0	34.0 30.0	20 1	75 75	1 1	600 600	 <p>SOT-23</p>
PSMDA05-6	5.0	6.0	18.0	17.0	20	120	5-6	350	 <p>SO-8</p>
PSMDA05C-4	5.0	6.0	19.0	30.0	100	350	4	500	 <p>SO-8</p>
PSMDA12C-4	12.0	13.3	29.0	20.0	1	150	4	500	
PSMDA15C-4	15.0	16.7	32.0	18.0	1	120	4	500	
PSMDA24C-4	24.0	26.7	45.0	13.0	1	100	4	500	
PSMDA05C-8	5.0	6.0	15.4	30.0	100	350	8	450	 <p>SO-14</p>
PSMDA12C-8	12.0	13.4	26.4	17.0	1	150	8	450	
PSMDA15C-8	15.0	16.7	32.4	14.0	1	120	8	450	
PSMDA24C-8	24.0	26.7	45.0	10.0	1	100	8	450	

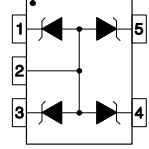
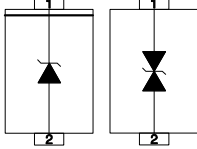
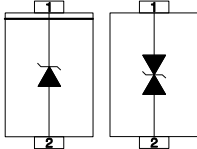
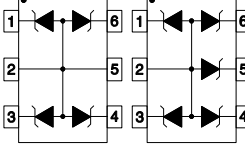
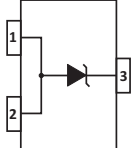
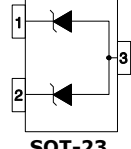
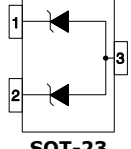
TVS DIODE ARRAYS									
PART NUMBER	STAND-OFF VOLTAGE - V_{WM}	MIN. BREAKDOWN VOLTAGE - V_{BR}	CLAMPING VOLTAGE - $V_c @ I_{PP}$	CURRENT I_{PP} @ 8/20 μ s - A	LEAKAGE CURRENT - μ A @ V_{WM}	CAPACITANCE C_j - pF	NUMBER OF LINES	POWER @ 8/20 μ s - WATTS	PIN CONFIGURATION
PSMF05	5.0	6.0	9.5	1.0	10	60	4	100	 SC70-5L
PSMF6.0AL	6.0	6.67	10.3	35.9	120	-	1	400	<p>Not all voltages are shown for the PSMFxxAL Series. Please consult the factory for other voltages.</p>  SOD-123FL
PSMF58AL	58.0	64.4	93.6	4.3	1	-	1	400	
Note: I_{PP} and P_{PP} @ 10/1000 μ s. Part numbers shown are unidirectional. Add a "C" suffix to specify bidirectional device, such as 'PSMF12CAL'.									
PSMF6.0BL	6.0	6.67	10.3	19.4	100	-	1	200	<p>Not all voltages are shown for the PSMFxxBL Series. Please consult the factory for other voltages.</p>  SOD-123FL
PSMF58BL	58.0	64.4	93.6	2.1	1	-	1	200	
Note: I_{PP} and P_{PP} @ 10/1000 μ s. Part numbers shown are unidirectional. Add a "C" suffix to specify bidirectional device, such as 'PSMF12CBL'.									
PSMS05	5.0	6.0	9.8	1.0	20	150	4-5	350	 SOT-23-6
PSMS12	12.0	13.3	19.0	1.0	1	80	4-5	350	
PSMS15	15.0	16.7	24.0	1.0	1	50	4-5	350	
PSMS24	24.0	26.7	40.0	1.0	1	40	4-5	350	
Note: Part numbers shown are unidirectional. Add a "C" suffix to specify bidirectional devices, such as 'PSMS05C'. PSMS05/C Series are identical to SMS05/C Series.									
PSOT03	3.3	4.0	10.9	43.0	125	500	1	500	 SOT-23
PSOT05	5.0	6.0	13.5	42.0	20	350	1	500	
PSOT08	8.0	8.5	16.9	34.0	10	250	1	500	
PSOT12	12.0	13.3	25.9	21.0	2	150	1	500	
PSOT15	15.0	16.7	30.0	17.0	1	100	1	500	
PSOT24	24.0	26.7	49.0	12.0	1	88	1	500	
PSOT36	36.0	40.0	76.8	9.0	1	80	1	500	
PSOT03C	3.3	4.0	10.9	43.0	125	300	1	500	
PSOT05C	5.0	6.0	13.5	42.0	20	210	1	500	 SOT-23
PSOT08C	8.0	8.5	16.9	34.0	10	150	1	500	
PSOT12C	12.0	13.3	25.9	21.0	2	90	1	500	
PSOT15C	15.0	16.7	30.0	17.0	1	60	1	500	
PSOT24C	24.0	26.7	49.0	12.0	1	63	1	500	
PSOT36C	36.0	40.0	76.8	9.0	1	60	1	500	
PSOT053	5.0	6.0	19.0	16.0	20	350	1	300	
PSOT123	12.0	13.3	28.0	11.0	1	150	1	300	
PSOT153	15.0	16.7	30.0	10.0	1	100	1	300	
PSOT243	24.0	26.7	50.0	6.0	1	88	1	300	
PSOT053C	5.0	6.0	19.0	16.0	20	210	1	300	
PSOT123C	12.0	13.3	28.0	11.0	1	90	1	300	
PSOT153C	15.0	16.7	30.0	10.0	1	60	1	300	
PSOT243C	24.0	26.7	50.0	6.0	1	63	1	300	
PSOT05CLP	5.0	6.0	9.8	1.0	10	210	1	300	 SOT-23

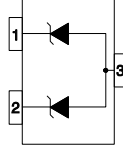
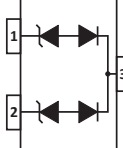
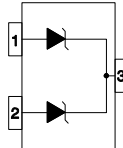
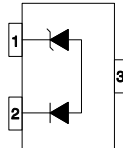
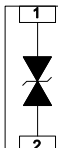
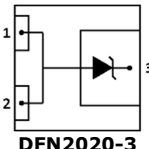
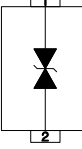
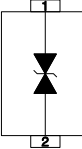
TVS DIODE ARRAYS									
PART NUMBER	STAND-OFF VOLTAGE - V_{WM}	MIN. BREAKDOWN VOLTAGE - V_{BR}	CLAMPING VOLTAGE - $V_C @ I_{PP}$	CURRENT I_{PP} @ 8/20 μ s - A	LEAKAGE CURRENT - μ A @ V_{WM}	CAPACITANCE C_j - pF	NUMBER OF LINES	POWER @ 8/20 μ s - WATTS	PIN CONFIGURATION
PSOT05LCC	5.0	6.0	15.0	20.0	10	120	1-2	300	 SOT-23
PSOT05ULC	5.0	6.0	9.8	1.0	5	0.8	2	250	 SOT-23
PSOT15KCA	12.8	14.3	33.0	9.0	0.1	120	2	300	 SOT-23
PSOT36KCA	33.0	36.0	66.0	6.0	0.1	45	2	300	
PSOT03LC	3.3	4.0	9.0	5.0	125	5	1	500	 SOT-23
PSOT05LC	5.0	6.0	11.0	5.0	20	5	1	500	
PSOT08LC	8.0	8.5	15.0	5.0	10	5	1	500	
PSOT12LC	12.0	13.3	23.0	5.0	1	5	1	500	
PSOT15LC	15.0	16.7	28.0	5.0	1	5	1	500	
PSOT24LC	24.0	26.7	46.0	5.0	1	5	1	500	
PSOT36LC	36.0	40.0	68.0	5.0	1	5	1	500	
PSSB05P	5.0	6.0	20.0	1.0	1	0.3	1	20	 DFN-2-0402
PTVS5.0A	5.0	6.2	14.7	204	2000	-	1	3000	 DFN2020-3
PTVS7.5A	7.0	8.0	19.0	200	1000	-	1	3000	
PTVS10A	10.0	11.10	23.0	148	50	-	1	3000	
PTVS12A	12.0	13.30	25.2	131	50	-	1	3000	
PTVS15A	15.0	16.70	28.8	111	50	-	1	3000	
PTVS18A	18.0	20.00	32.0	97	50	-	1	3000	
PTVS24A	24.0	25.5	43.5	69	50	-	1	3000	
RSB6.8B	4.7	5.7	-	-	0.5	30	1	10	 SOD-323
Note: I_{PP} and P_{PP} @ 10/1000 μ s, Leakage Current - V_{WM} @ 3.5V									
RSB6.8G	4.7	5.7	-	-	0.5	15	1	10	 SOD-723
Note: I_{PP} and P_{PP} @ 10/1000 μ s, Leakage Current - V_{WM} @ 3.5V									

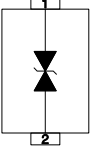
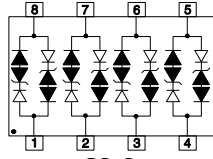
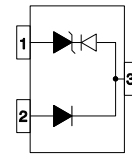
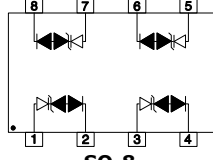
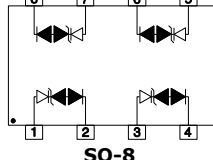
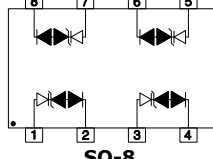
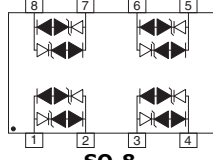
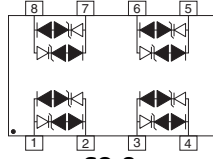
TVS DIODE ARRAYS									
PART NUMBER	STAND-OFF VOLTAGE - V_{WM}	MIN. BREAKDOWN VOLTAGE - V_{BR}	CLAMPING VOLTAGE - $V_c @ I_{PP}$	CURRENT I_{PP} @ 8/20 μ s - A	LEAKAGE CURRENT - μ A @ V_{WM}	CAPACITANCE C_j - pF	NUMBER OF LINES	POWER @ 8/20 μ s - WATTS	PIN CONFIGURATION
RSB6.8S	4.7	5.7	-	-	0.5	30	1	10	 <p>SC-79</p>
Not: I_{PP} and P_{PP} @ 10/1000μs, Leakage Current - V_{WM} @ 3.5V									
SLVDA2.8LC	2.8	3.0	21.0	30.0	1	5	4P	600	 <p>SO-8</p>
SLVU2.8	2.8	3.0	21.0	30.0	1	2.5	1	600	 <p>SOT-23</p>
SLVU2.8-4	2.8	3.0	21.0	30.0	1	3	2P	600	 <p>SO-8</p>
SLVU2.8-4G	2.8	3.0	18.0	24.0	0.1	2	2P	600	 <p>SO-8</p>
SLVU2.8-4LC	2.8	3.0	18.0	24.0	0.1	1.5	2P	600	 <p>SO-8</p>
SLVU2.8-8	2.8	3.0	17.0	30.0	1	6.0	4P	600	 <p>SO-8</p>
SLVU2.8-8G	2.8	3.0	17.0	30.0	1	3.7	4P	500	 <p>SO-8</p>

TVS DIODE ARRAYS

PART NUMBER	STAND-OFF VOLTAGE - V_{WM}	MIN. BREAKDOWN VOLTAGE - V_{BR}	CLAMPING VOLTAGE - $V_C @ I_{PP}$	CURRENT I_{PP} @ 8/20 μ s - A	LEAKAGE CURRENT - μ A @ V_{WM}	CAPACITANCE C_j - pF	NUMBER OF LINES	POWER @ 8/20 μ s - WATTS	PIN CONFIGURATION	
SM14M05C	5.0	6.0	17.8	47.0	100	500	8	800	<p>SO-14</p>	
SM14M08C	8.0	8.5	20.1	40.0	10	440	8	800		
SM14M12C	12.0	13.3	26.6	34.0	2	385	8	800		
SM14M15C	15.0	16.7	33.1	25.0	2	300	8	800		
SM14M24C	24.0	26.7	42.1	19.0	2	200	8	800		
SM1603	3.3	4.0	10.9	43.0	125	800	8	500	<p>SO-16</p>	
SM1605	5.0	6.0	13.5	42.0	10	550	8	500		
SM1608	8.0	8.5	16.9	34.0	10	500	8	500		
SM1612	12.0	13.4	25.9	21.0	2	185	8	500		
SM1615	15.0	16.7	30.0	17.0	2	140	8	500		
SM1624	24.0	26.7	49.0	12.0	2	88	8	500	<p>SO-16</p>	
SM1603C	3.3	4.0	10.9	43.0	125	450	8	500		
SM1605C	5.0	6.0	13.5	42.0	10	310	8	500		
SM1608C	8.0	8.5	16.9	34.0	10	280	8	500		
SM1612C	12.0	13.4	25.9	21.0	2	105	8	500		
SM1615C	15.0	16.7	30.0	17.0	2	80	8	500	<p>SO-16</p>	
SM1624C	24.0	26.7	49.0	12.0	2	50	8	500		
SM16LC03	3.3	4.5	20.0	35.0	125	15	8	500		
SM16LC05	5.0	6.0	24.0	42.0	20	15	8	500		
SM16LC08	8.0	8.5	26.0	30.0	10	15	8	500		
SM16LC12	12.0	13.3	33.0	21.0	2	15	8	500	<p>SO-16</p>	
SM16LC15	15.0	16.7	39.0	15.0	2	15	8	500		
SM16LC24	24.0	26.7	57.0	10.0	2	15	8	500		
SM16LC36	36.0	40.0	72.0	7.0	2	15	8	500		
SM16LC03C	3.3	4.5	20.0	35.0	125	15	8	500		<p>SO-16</p>
SM16LC05C	5.0	6.0	24.0	42.0	20	15	8	500		
SM16LC08C	8.0	8.5	26.0	30.0	10	15	8	500		
SM16LC12C	12.0	13.3	33.0	21.0	2	15	8	500		
SM16LC15C	15.0	16.7	39.0	15.0	2	15	8	500		
SM16LC24C	24.0	26.7	57.0	10.0	2	15	8	500	<p>SO-16</p>	
SM16LC36C	36.0	40.0	72.0	7.0	2	15	8	500		
SM8LC05	5.0	6.0	24.6	45.0	100	25	2P	800		<p>SO-8</p>
SM8LC08	8.0	8.5	25.5	40.0	10	25	2P	800		
SM8LC12	12.0	13.3	32.9	34.0	4	25	2P	800		
SM8LC15	15.0	16.7	38.5	27.0	4	25	2P	800		
SM8LC24	24.0	26.7	48.5	22.0	4	25	2P	800		
SMDA03	3.3	4.0	7.0	5.0	125	800	4	500	<p>SO-8</p>	
SMDA05	5.0	6.0	10.0	5.0	20	550	4	500		
SMDA08	8.0	8.5	14.0	5.0	10	500	4	500		
SMDA12	12.0	13.3	22.0	5.0	1	185	4	500		
SMDA15	15.0	16.7	27.0	5.0	1	140	4	500		
SMDA24	24.0	26.7	45.0	5.0	1	88	4	500	<p>SO-8</p>	
SMDA36	36.0	40.0	65.0	5.0	1	80	4	500		
SMDA03C	3.3	4.5	9.0	5.0	125	450	4	500		
SMDA05C	5.0	6.0	10.0	5.0	20	308	4	500		
SMDA08C	8.0	8.5	14.0	5.0	10	300	4	500		
SMDA12C	12.0	13.3	22.0	5.0	1	105	4	500	<p>SO-8</p>	
SMDA15C	15.0	16.7	27.0	5.0	1	80	4	500		
SMDA24C	24.0	26.7	45.0	5.0	1	50	4	500		
SMDA36C	36.0	40.0	65.0	5.0	1	45	4	500		

TVS DIODE ARRAYS									
PART NUMBER	STAND-OFF VOLTAGE - V_{WM}	MIN. BREAKDOWN VOLTAGE - V_{BR}	CLAMPING VOLTAGE - $V_C @ I_{PP}$	CURRENT I_{PP} @ 8/20 μ s - A	LEAKAGE CURRENT - μ A @ V_{WM}	CAPACITANCE C_j - pF	NUMBER OF LINES	POWER @ 8/20 μ s - WATTS	PIN CONFIGURATION
SMDA03-6	3.3	4.0	9.0	5.0	75	300	5-6	300	<p>SO-8</p>
SMDA05-6	5.0	6.0	11.0	5.0	20	308	5-6	300	
SMDA12-6	12.0	13.3	24.0	5.0	1	185	5-6	300	
SMDA15-6	15.0	16.7	30.0	5.0	1	140	5-6	300	
SMDA24-6	24.0	26.7	55.0	5.0	1	80	5-6	300	
SMDA05CM	5.0	6.0	19.0	30.0	100	350	4-7	500	<p>SO-8</p>
SMDA08CM	8.0	8.5	23.7	24.0	10	300	4-7	500	
SMDA12CM	12.0	13.4	29.2	20.0	1	150	4-7	500	
SMDA15CM	15.0	16.7	31.1	18.0	1	100	4-7	500	
SMDA24CM	24.0	26.7	45.0	13.0	1	63	4-7	500	
SMDA05CN-5	5.0	6.0	19.0	30.0	10	350	5	500	<p>SO-8</p>
SMDA12CN-5	12.0	13.4	29.0	20.0	1	150	5	500	
SMDA15CN-5	15.0	16.7	31.0	18.0	1	75	5	500	
SMDA24CN-5	24.0	26.7	45.0	13.0	1	63	5	500	
SMDA03LC	3.3	4.5	10.9	43.0	125	15	4	500	<p>SO-8</p>
SMDA05LC	5.0	6.0	13.5	42.0	20	15	4	500	
SMDA08LC	8.0	8.5	16.9	34.0	10	15	4	500	
SMDA12LC	12.0	13.3	25.9	27.0	1	15	4	500	
SMDA15LC	15.0	16.7	30.0	17.0	1	15	4	500	
SMDA24LC	24.0	26.7	49.0	12.0	1	15	4	500	
SMDA03LCC	3.3	4.5	10.9	43.0	125	15	4	500	<p>SO-8</p>
SMDA05LCC	5.0	6.0	13.5	42.0	20	15	4	500	
SMDA08LCC	8.0	8.5	16.9	34.0	10	15	4	500	
SMDA15LCC	15.0	16.7	30.0	17.0	1	15	4	500	
SMDA24LCC	24.0	26.7	49.0	12.0	1	15	4	500	
SMDB05	5.0	6.0	24.6	45.0	25	880	4	800	<p>SO-8</p>
SMDB08	8.0	8.5	25.5	40.0	10	800	4	800	
SMDB12	12.0	13.3	32.9	34.0	2	440	4	800	
SMDB15	15.0	16.7	38.5	27.0	2	400	4	800	
SMDB24	24.0	26.7	48.5	20.0	2	275	4	800	
SMDB05C	5.0	6.0	24.6	45.0	25	493	4	800	<p>SO-8</p>
SMDB08C	8.0	8.5	25.5	40.0	10	450	4	800	
SMDB12C	12.0	13.3	32.9	34.0	2	248	4	800	
SMDB15C	15.0	16.7	38.5	27.0	2	225	4	800	
SMDB24C	24.0	26.7	48.5	20.0	2	155	4	800	
SMDB712C	7.0 12.0	8.5 13.3	25.5 32.9	40.0 34.0	10 2	284	1	800	<p>SO-8</p>

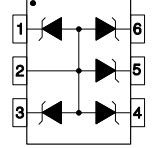
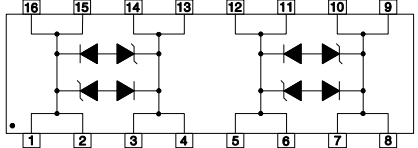
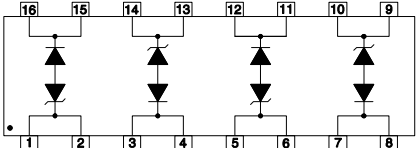
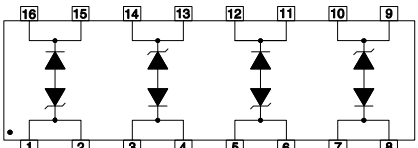
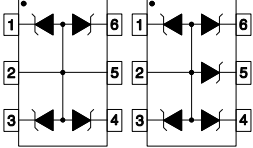
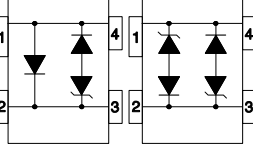
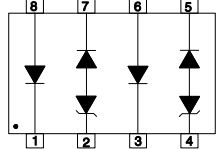
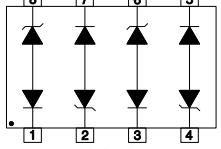
TVS DIODE ARRAYS									
PART NUMBER	STAND-OFF VOLTAGE - V_{WM}	MIN. BREAKDOWN VOLTAGE - V_{BR}	CLAMPING VOLTAGE - $V_C @ I_{PP}$	CURRENT I_{PP} @ 8/20 μ s - A	LEAKAGE CURRENT - μ A @ V_{WM}	CAPACITANCE C_j - pF	NUMBER OF LINES	POWER @ 8/20 μ s - WATTS	PIN CONFIGURATION
SMF05C	5.0	6.0	9.8	5.0	5	60	4-5	100	 <p>SC70-6L</p>
SMF12C	12.0	13.3	18.0	5.0	1	30	4-5	100	
SMF15C	15.0	16.7	22.0	5.0	1	25	4-5	100	
SMF24C	24.0	26.7	50.0	5.0	1	20	4-5	100	
SMLC6.5C-2	6.5	7.2	28.0	150.0	300	30	2P	3900	 <p>SO-16</p>
SMLC12C-2	12.0	13.3	35.0	140.0	2	30	2P	3900	
SMP6LC05-2P	5.0	6.0	26.0	150	300	15	2P	3900	 <p>SO-16</p>
SMP6LC6.5-2P	6.5	7.2	28.0	150	300	15	2P	3900	
SMP6LC08-2P	8.0	8.6	30.0	140	25	15	2P	3900	
SMP6LC12-2P	12.0	13.3	35.0	140	2	15	2P	3900	
SMP6LC15-2P	15.0	16.7	50.0	110	2	15	2P	3900	
SMP6LC24-2P	24.0	26.7	57.0	80	2	15	2P	3900	
SMP6LLC05-2P	5.0	6.0	26.0	150.0	300	5	2P	3900	
SMP6LLC6.5-2P	6.5	7.2	28.0	150.0	300	5	2P	3900	 <p>SO-16</p>
SMP6LLC12-2P	12.0	13.3	35.0	140.0	2	5	2P	3900	
SMS05	5.0	6.0	9.8	1.0	20	150	4	350	 <p>SOT-23-6</p>
SMS12	12.0	13.3	19.0	1.0	1	80	4	350	
SMS15	15.0	16.7	24.0	1.0	1	50	4	350	
SMS24	24.0	26.7	40.0	1.0	1	40	4	350	
Note: Part numbers shown are unidirectional. Add a "C" suffix to specify bidirectional devices, such as 'SMS05C'. PSMSxx/C Series are identical to SMSxx/C Series									
USB0403	3.3	4.0	19.0	20.0	125	5	1	350	 <p>SOT-143</p>
USB0405	5.0	6.0	18.3	17.0	20	5	1	350	
USB0408	8.0	8.5	18.5	17.0	10	5	1	350	
USB0412	12.0	13.3	28.6	11.0	1	5	1	350	
USB0415	15.0	16.6	31.8	10.0	1	5	1	350	
USB0424	24.0	26.7	56.0	6.0	1	5	1	350	
Note: Part numbers shown are unidirectional. Add a "C" suffix to specify bidirectional devices, such as 'USB0415C'.									
USB50803	3.3	4.5	11.0	5.0	125	3	1	500	 <p>SO-8</p>
USB50805	5.0	6.0	13.0	5.0	20	3	1	500	
USB50812	12.0	13.3	26.0	5.0	1	3	1	500	
USB50815	15.0	16.7	32.0	5.0	1	3	1	500	
USB50824	24.0	26.7	57.0	5.0	1	3	1	500	
USB50803C	3.3	4.5	11.0	5.0	125	3	1	500	 <p>SO-8</p>
USB50805C	5.0	6.0	13.0	5.0	20	3	1	500	
USB50812C	12.0	13.3	26.0	5.0	1	3	1	500	
USB50815C	15.0	16.7	32.0	5.0	1	3	1	500	
USB50824C	24.0	26.7	57.0	5.0	1	3	1	500	

TVS DIODE ARRAYS

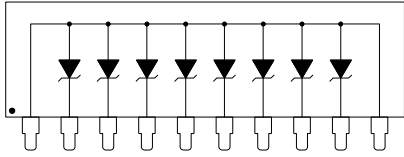
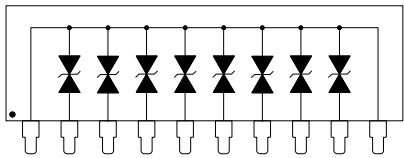
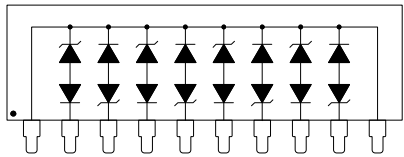
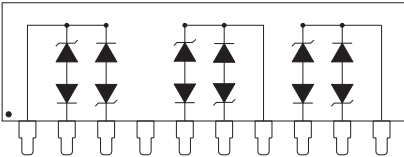
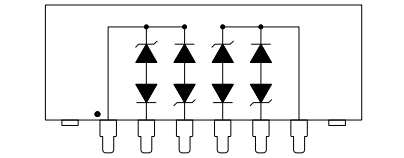
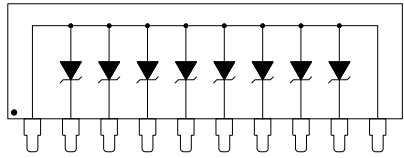
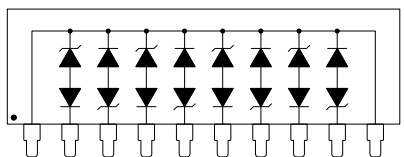
PART NUMBER	STAND-OFF VOLTAGE - V_{WM}	MIN. BREAKDOWN VOLTAGE - V_{BR}	CLAMPING VOLTAGE - $V_c @ I_{PP}$	CURRENT I_{PP} @ 8/20 μ s - A	LEAKAGE CURRENT - μ A @ V_{WM}	CAPACITANCE C_j - pF	NUMBER OF LINES	POWER @ 8/20 μ s - WATTS	PIN CONFIGURATION
VS10P05	5.0	6.0	12.5	10.0	100	880	8	800	 <p>10 PIN VSIP</p>
VS10P08	8.0	8.5	16.6	10.0	10	800	8	800	
VS10P12	12.0	13.3	22.7	10.0	1	440	8	800	
VS10P15	15.0	16.7	28.5	10.0	1	-	8	800	
VS10P24	24.0	26.7	45.6	10.0	1	-	8	800	
VS10P05C	5.0	6.0	12.5	10.0	100	500	8	800	 <p>10 PIN VSIP</p>
VS10P08C	8.0	8.5	16.6	10.0	10	-	8	800	
VS10P12C	12.0	13.3	22.7	10.0	1	-	8	800	
VS10P15C	15.0	16.7	28.5	10.0	1	-	8	800	
VS10P24C	24.0	26.7	45.6	10.0	1	275	8	800	
VS10P03LC	3.3	4.5	9.0	5.0	125	15	4	300	 <p>10 PIN VSIP</p>
VS10P05LC	5.0	6.0	12.5	10.0	100	25	4	800	
VS10P08LC	8.0	8.5	16.6	10.0	10	25	4	800	
VS10P12LC	12.0	13.3	22.7	10.0	1	25	4	800	
VS10P15LC	15.0	16.7	28.5	10.0	1	25	4	800	
VS10P24LC	24.0	26.7	45.6	10.0	1	25	4	800	
VS10P05LCI	5.0	6.0	12.5	10.0	100	25	3	800	 <p>10 PIN VSIP</p>
VS10P08LCI	8.0	8.5	16.6	10.0	10	25	3	800	
VS10P12LCI	12.0	13.3	22.7	10.0	1	25	3	800	
VS10P15LCI	15.0	16.7	28.5	10.0	1	25	3	800	
VS10P24LCI	24.0	26.7	45.6	10.0	1	25	3	800	
VS06P05LCI	5.0	6.0	16.5	36.0	300	50	2	600	 <p>6 PIN VSIP</p>
Note: I_{PP} and P_{PP} @ 10/1000 μ s									
VS06P05LCI	5.0	6.0	16.5	36.0	300	50	2	600	 <p>10 PIN VSIP</p>
VS10P05	5.0	6.0	9.1	10.0	300	4000	8	3400	
VS10P08	8.0	8.5	12.0	10.0	200	-	8	3400	
VS10P12	12.0	13.3	18.8	10.0	2	-	8	3400	
VS10P15	15.0	16.7	23.6	10.0	2	-	8	3400	
VS10P24	24.0	26.7	37.8	10.0	2	1250	8	3400	
VS10P28	28.0	31.1	44.0	10.0	2	-	8	3400	
VS10P33	33.0	36.7	51.9	10.0	2	-	8	3400	
VS10P36	36.0	40.0	56.6	10.0	2	-	8	3400	
VS10P05C	5.0	6.0	9.1	10.0	300	2000	8	3400	
VS10P08C	8.0	8.5	12.0	10.0	200	-	8	3400	
VS10P12C	12.0	13.3	18.8	10.0	2	-	8	3400	
VS10P15C	15.0	16.7	23.6	10.0	2	-	8	3400	
VS10P24C	24.0	26.7	37.8	10.0	2	1250	8	3400	
VS10P28C	28.0	31.1	44.0	10.0	2	-	8	3400	
VS10P33C	33.0	36.7	51.9	10.0	2	400	8	3400	
VS10P36C	36.0	40.0	56.6	10.0	2	-	8	3400	
VS10P05LC	5.0	6.0	9.1	10.0	300	100	4P	3400	 <p>10 PIN VSIP</p>
VS10P08LC	8.0	8.5	12.0	10.0	200	100	4P	3400	
VS10P12LC	12.0	13.3	18.8	10.0	2	100	4P	3400	
VS10P15LC	15.0	16.7	23.6	10.0	2	100	4P	3400	
VS10P24LC	24.0	26.7	37.8	10.0	2	100	4P	3400	
VS10P28LC	28.0	31.1	44.0	10.0	2	100	4P	3400	
VS10P33LC	33.0	36.7	51.9	10.0	2	100	4P	3400	
VS10P36LC	36.0	40.0	56.6	10.0	2	100	4P	3400	

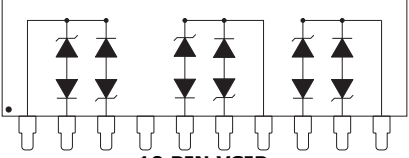
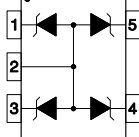
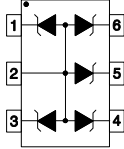
TVS DIODE ARRAYS									
PART NUMBER	STAND-OFF VOLTAGE - V_{WM}	MIN. BREAKDOWN VOLTAGE - V_{BR}	CLAMPING VOLTAGE - V_C @ I_{PP}	CURRENT I_{PP} @ 8/20 μ s - A	LEAKAGE CURRENT - μ A @ V_{WM}	CAPACITANCE C_j - pF	NUMBER OF LINES	POWER @ 8/20 μ s - WATTS	PIN CONFIGURATION
VSB10P05LCI	5.0	6.0	9.1	10.0	300	100	3P	3400	 <p>10 PIN VSIP</p>
VSB10P08LCI	8.0	8.5	12.0	10.0	200	100	3P	3400	
VSB10P12LCI	12.0	13.3	18.8	10.0	2	100	3P	3400	
VSB10P15LCI	15.0	16.7	23.6	10.0	2	100	3P	3400	
VSB10P24LCI	24.0	26.7	37.8	10.0	2	100	3P	3400	
VSB10P28LCI	28.0	31.1	44.0	10.0	2	100	3P	3400	
VSB10P33LCI	33.0	36.7	51.9	10.0	2	100	3P	3400	
VSB10P36LCI	36.0	40.0	56.6	10.0	2	100	3P	3400	
VSMF05LC	5.0	6.0	12.0	2.0	1	9	4	25	 <p>SOT-953</p>
Note: Also available in SOT-553 package configuration, part number MSMF05LC									
VSMF05LCC	5.0	6.0	12.0	2	1	9	4-5	25	 <p>SOT-963</p>
Note: Also available in SOT-563 package configuration, part number MSMF05LC									

STEERING DIODE HYBRID ARRAYS									
PART NUMBER	STAND-OFF VOLTAGE - V_{WM}	MIN. BREAKDOWN VOLTAGE - V_{BR}	CLAMPING VOLTAGE - $V_c @ I_{PP}$	CURRENT I_{PP} @ 8/20 μ s - A	LEAKAGE CURRENT - μ A @ V_{WM}	CAPACITANCE $C_{i(sd)}$ - pF	NUMBER OF LINES	POWER @ 8/20 μ s - WATTS	PIN CONFIGURATION
DSL03-24	24.0	26.0	55.0	15.0	0.1	5.0	2	500	<p>SOT-23-6</p>
DSL03-24T	19.0	-	-	30.0	0.01	3.0	2	-	<p>SOT-23-6</p>
PAM04DF100524	5.0	6.0	12.0	1.0	0.5	0.7	4	150	<p>DFN-10</p>
PAM05SC700504F	5.0	6.0	25.0	5.0	3	1.9	4	200	<p>SC70-6L</p>
PAM13ST2305	5.0	6.0	15.0	5.0	5	3.5	4	500	<p>SOT-23-6</p>
PAM15ST4305	5.0	6.0	20.0	28.0	5	10	2	500	<p>SOT-143</p>
PAZC099	5.0	6.0	12.0	1.0	0.5	0.6	4	100	<p>SOT-23-6</p>
PGBT2504	2.5	3.0	6.0	5.0	0.1	1.0	2P	500	<p>DFN-10</p>
PLC03-6	6.0	6.8	20.0	100.0	25	8	2	2K	<p>SO-8</p>

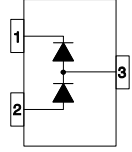
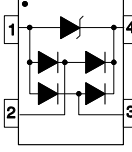
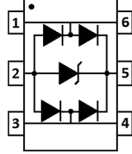
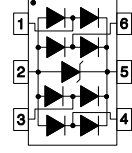
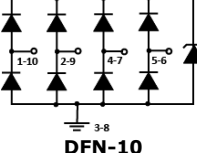
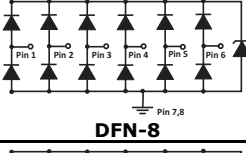
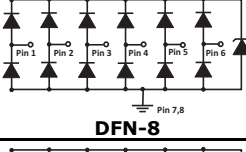
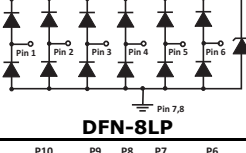
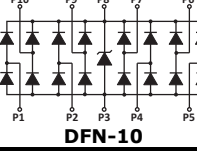
STEERING DIODE HYBRID ARRAYS									
PART NUMBER	STAND-OFF VOLTAGE - V_{WM}	MIN. BREAKDOWN VOLTAGE - V_{BR}	CLAMPING VOLTAGE - $V_c @ I_{PP}$	CURRENT I_{PP} @ 8/20 μ s - A	LEAKAGE CURRENT - μ A @ V_{WM}	CAPACITANCE $C_{j(sD)}$ - pF	NUMBER OF LINES	POWER @ 8/20 μ s - WATTS	PIN CONFIGURATION
PLC497	1.0	1.3	5.0	5.0	20	2.5	1	200	 <p>SOT-23</p>
PLR0502	5.0	6.0	20.0	10.0	1	0.6	2	200	 <p>SOT-543</p>
PLR0502-6	5.0	6.0	17.0	3.0	1	0.7	2	50	 <p>SC-89</p>
PLR0504F	5.0	6.0	25.0	5.0	3	1.9	4	200	 <p>SC70-6L</p>
PLR0504PLCN	5.0	6.0	15.6	16.0	0.5	1.5	4	250	 <p>DFN-10</p>
PLR0506	5.0	6.0	18.0	4.0	3	0.8	6	72	 <p>DFN-8</p>
PLR0506LC	5.0	6.0	12.0	1.0	0.1	0.1	6	64	 <p>DFN-8</p>
PLR0506LP	5.0	6.0	18.0	4.0	3	0.8	6	72	 <p>DFN-8LP</p>
PLR0508	5.0	6.0	13.0	5.0	1	1.6	8	200	 <p>DFN-10</p>

STEERING DIODE HYBRID ARRAYS									
PART NUMBER	STAND-OFF VOLTAGE - V_{WM}	MIN. BREAKDOWN VOLTAGE - V_{BR}	CLAMPING VOLTAGE - $V_c @ I_{PP}$	CURRENT I_{PP} @ 8/20 μ s - A	LEAKAGE CURRENT - μ A @ V_{WM}	CAPACITANCE $C_{i(sD)}$ - pF	NUMBER OF LINES	POWER @ 8/20 μ s - WATTS	PIN CONFIGURATION
PLR0514LC	5.0	6.0	12.0	1.0	1	0.6	4	-	<p>DFN-10</p>
PLR0524	5.0	6.0	12.0	1.0	0.5	0.7	4	150	<p>DFN-10</p>
PLR0524P	5.0	6.0	16.5	4.0	0.5	0.8	4	60	<p>DFN-10</p>
PLR2504	2.5	2.0	7.5	10.0	0.5	4	4P	300	<p>DFN-10</p>
PLR3304	3.3	3.3	10.0	10.0	0.1	4.0	4	400	<p>DFN-10</p>
PLR3304PLCN	3.3	4.0	15.0	17.0	0.1	1.5	4	250	<p>DFN-10</p>
PLR3343	3.3	5.6	10.0	1.0	1	0.25	4	150	<p>DFN-10</p>
PLR4045	3.3	4.0	20.0	30.0	0.1	1.6	4	600	<p>MSOP-10</p>
PLRT0504LC	5.0	6.2	6.0	3.0	0.05	0.4	4	20	<p>DFN-10</p>
PRUSB05UBK	5.0	6.0	12.0	1.0	5	2.5	4	500	<p>DFN-14</p>

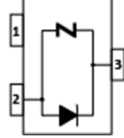
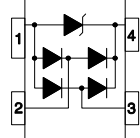
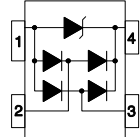
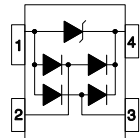
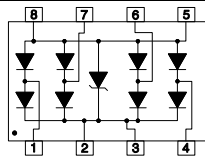
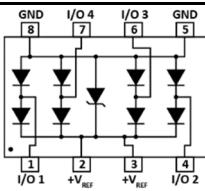
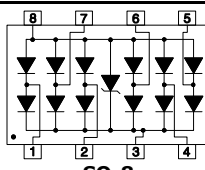
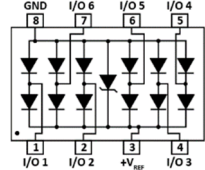



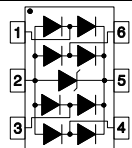
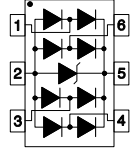
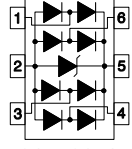
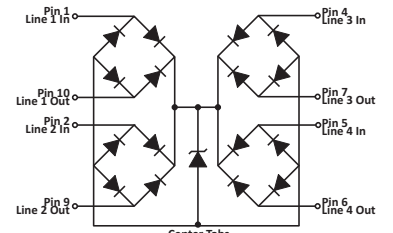
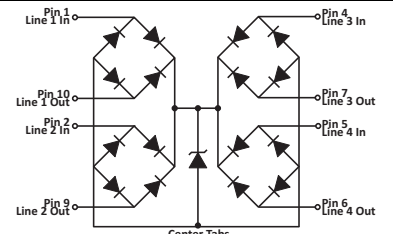
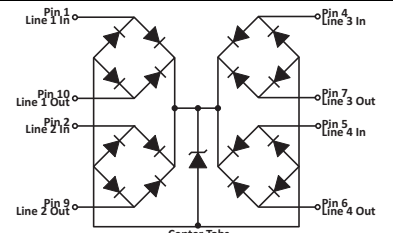
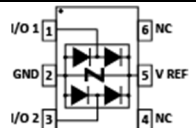

STEERING DIODE HYBRID ARRAYS									
PART NUMBER	STAND-OFF VOLTAGE - V_{WM}	MIN. BREAKDOWN VOLTAGE - V_{BR}	CLAMPING VOLTAGE - $V_c @ I_{PP}$	CURRENT I_{PP} @ 8/20 μ s - A	LEAKAGE CURRENT - μ A @ V_{WM}	CAPACITANCE $C_{j(sD)}$ - pF	NUMBER OF LINES	POWER @ 8/20 μ s - WATTS	PIN CONFIGURATION
PSB15-LC	15.0	-	12.0	25.0	0.1	3.0	1	500	 SOT-23
PSR05	5.0	6.0	20.0	28.0	5	10	2	500	 SOT-143
PSR05LC	5.0	6.0	20.0	28.0	5	2.5	2	500	 SOT-143
PSR3.3	3.3	-	15.0	10.0	1	0.6	2	150	 SOT-143
PSRDA3.3-4	3.3	4.0	6.5	1.0	125	5	4	500	 SO-8
PSRDA05-4	5.0	6.0	9.8	1.0	20	5	4	500	
PSRDA12-4	12.0	13.3	19.0	1.0	1	5	4	500	
PSRDA15-4	15.0	16.7	24.0	1.0	1	5	4	500	
PSRDA2.5-4A	2.5	3.0	5.5	1.0	0.5	5	4	500	 SO-8
PSRDA3.3-4A	3.3	4.0	6.5	1.0	0.5	5	4	500	
PSRDA3.3-6	3.3	4.0	6.5	1.0	125	5	6	500	 SO-8
PSRDA05-6	5.0	6.0	9.8	1.0	20	5	6	500	
PSRDA2.5-6A	2.5	3.6	5.5	1.0	0.5	5	6	500	 SO-8
PSRDA3.3-6A	3.3	4.0	6.5	1.0	0.5	5	6	500	

STEERING DIODE HYBRID ARRAYS									
PART NUMBER	STAND-OFF VOLTAGE - V_{WM}	MIN. BREAKDOWN VOLTAGE - V_{BR}	CLAMPING VOLTAGE - $V_c @ I_{PP}$	CURRENT I_{PP} @ 8/20 μ s - A	LEAKAGE CURRENT - μ A @ V_{WM}	CAPACITANCE $C_{I(SD)}$ - pF	NUMBER OF LINES	POWER @ 8/20 μ s - WATTS	PIN CONFIGURATION
PSRV2.8-2LC	2.8	-	8.5	5.0	0.1	1	2	300	<p>DFN-6</p>
PSRV3.3-2LC	3.3	3.5	15.0	10.0	0.1	1	2	300	
PSRV05-2LC	5.0	6.0	20.0	17.0	0.5	1	2	300	
PUSB05UBK	5.0	6.0	15.0	5.0	5	3.5	4	500	<p>SOT-23-6</p>
PUSB403	3.3	4.5	7.4	5.0	0.1	0.6	4	-	<p>DFN-10</p>
PUSB6B	5.25	6.0	13.2	35.0	10	15	2	500	<p>SO-8</p>
SR12	12.0	13.3	30.0	16.0	1	10	2	500	<p>SOT-143</p>
SR2.8	2.8	3.0 @ 2 μ A	8.5	5.0	1	4.5	2	300	<p>SOT-143</p>
SR3.3	3.3	3.3 @ 2 μ A	15.0	10.0	1	4.5	2	300	
SRV05-4	5.0	6.0	15.0	5.0	5	3.5	4	500	<p>SOT-23-6</p>
SRV05-4-A	5.0	6.0	21.0	12.0	1	3.0	4	250	<p>SOT-23-6</p>

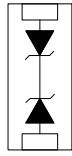
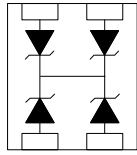
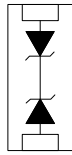
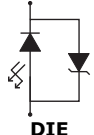
STEERING DIODE HYBRID ARRAYS

PART NUMBER	STAND-OFF VOLTAGE - V_{WM}	MIN. BREAKDOWN VOLTAGE - V_{BR}	CLAMPING VOLTAGE - $V_c @ I_{PP}$	CURRENT I_{PP} @ 8/20 μ s - A	LEAKAGE CURRENT - μ A @ V_{WM}	CAPACITANCE $C_{j(sD)}$ - pF	NUMBER OF LINES	POWER @ 8/20 μ s - WATTS	PIN CONFIGURATION
SRV05-4LC	5.0	6.0	15.0	5.0	5	0.7	4	500	 <p>SOT-23-6</p>
SRV05-4M	5.0	6.0	14.0	5.0	5	4.5	4	400	 <p>SOT-23-6</p>
SRV2.8-4	2.8	3.0	8.5	5.0	5	3.5	4	600	 <p>SOT-23-6</p>
SRV25-4	2.5	3.0	7.4	10.0	0.5	3.5	4	800	 <p>DFN-10</p>
SRV25-4LC	2.5	3.0	7.4	10.0	0.1	1.0	4	400	 <p>DFN-10</p>
SRV3.3-4	3.3	3.9	12.5	15.0	0.5	3.5	4	800	 <p>DFN-10</p>
TRV24-2LC	24.0	-	20.0	25.0	0.01	3	2	500	 <p>SOT-23-6</p>

STEERING DIODE HYBRID ARRAYS									
PART NUMBER	STAND-OFF VOLTAGE - V_{WM}	MIN. BREAKDOWN VOLTAGE - V_{BR}	CLAMPING VOLTAGE - $V_c @ I_{PP}$	CURRENT I_{PP} @ 8/20 μ s - A	LEAKAGE CURRENT - μ A @ V_{WM}	CAPACITANCE $C_{I(SD)}$ - pF	NUMBER OF LINES	POWER @ 8/20 μ s - WATTS	PIN CONFIGURATION
TRV24-4LC	24	-	18.0	35.0	0.01	3	4	650	<p>SOT-23-6</p>
TRV03-4LC	3.3	6.0	5.0	5.0	1.0	0.7	4	300	<p>SOT-23-6</p>
TRV05-4LC	5.0	6.0	5.5	5.0	1.0	0.7	4	300	

CHIPSCALE TVS ARRAYS									
PART NUMBER	STAND-OFF VOLTAGE - V_{WM}	MIN. BREAKDOWN VOLTAGE - V_{BRK}	CLAMPING VOLTAGE - V_C @ I_{PP}	CURRENT I_{PP} @ 8/20 μ s - A	LEAKAGE CURRENT - μ A @ V_{WM}	CAPACITANCE C_T - pF	NUMBER OF LINES	POWER @ 8/20 μ s - WATTS	PIN CONFIGURATION
P0402FC3.3C	3.3	4.0	12.5	20.0	75	150	1	250	 <p>0402</p>
P0402FC05C	5.0	6.0	14.7	17.0	10	100	1	250	
P0402FC08C	8.0	8.5	19.2	13.0	10	75	1	250	
P0402FC12C	12.0	13.3	29.7	9.0	1	50	1	250	
P0402FC15C	15.0	16.7	35.7	7.0	1	40	1	250	
P0402FC24C	24.0	26.7	55.0	5.0	1	30	1	250	
P0402FC36C	36.0	40.0	84.0	3.0	1	25	1	250	
P0404FC3.3C	3.3	4.0	12.5	20.0	75	150	1-3	250	 <p>0404</p>
P0404FC05C	5.0	6.0	14.7	17.0	10	100	1-3	250	
P0404FC08C	8.0	8.5	19.2	13.0	10	75	1-3	250	
P0404FC12C	12.0	13.3	29.7	9.0	1	50	1-3	250	
P0404FC15C	15.0	16.7	35.7	7.0	1	40	1-3	250	
P0404FC24C	24.0	26.7	55.0	5.0	1	30	1-3	250	
P0404FC36C	36.0	40.0	70.0	3.0	1	25	1-3	250	
Note: P040xFC Series are patented under U.S. Patent No. Des. D456,367S. Maximum Leakage current < 5 μ A @ 2.8V for P040xFC3.3C, < 500nA @ 3.3V for P040xFC05C and < 200nA @ 5V for P040xFC08C.									
PLED05F189	5.0	6.0	-	-	10	10	1	-	 <p>DIE</p>
PLED0811PU	8.0	8.5	-	-	1	70	1	-	 <p>DIE</p>
PLED1211PU	13.3	12.0	-	-	1	50	1	-	
PLED3631X23NB	36.0	40.0	-	-	1	60	1	-	 <p>DIE</p>
PLED1831X23NB	18.0	20.0	-	-	1	40	1	-	
PLED508	4.7	5.7	-	-	1	15	-	-	 <p>DIE</p>
PLED508U	5.0	6.0	-	-	0.1	80	-	-	 <p>DIE</p>
PLED511	4.7	5.7	13.0	1.0	1	15	-	-	 <p>DIE</p>
PLED511U	5.0	6.0	-	-	0.5	80	-	-	 <p>DIE</p>

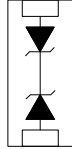
CHIPSCALE TVS ARRAYS									
PART NUMBER	STAND-OFF VOLTAGE - V_{WM}	MIN. BREAKDOWN VOLTAGE - V_{BR}	CLAMPING VOLTAGE - $V_C @ I_{PP}$	CURRENT I_{PP} @ 8/20 μ s - A	LEAKAGE CURRENT - μ A @ V_{WM}	CAPACITANCE C_T - pF	NUMBER OF LINES	POWER @ 8/20 μ s - WATTS	PIN CONFIGURATION  U0402
U0402FC3.3C	3.3	4.0	12.5	20.0	75	150	1	250	
U0402FC05C	5.0	6.0	14.7	17.0	10	100	1	250	
U0402FC08C	8.0	8.5	19.2	13.0	10	75	1	250	
U0402FC12C	12.0	13.3	29.7	9.0	1	50	1	250	
U0402FC15C	15.0	16.7	35.7	7.0	1	40	1	250	
U0402FC24C	24.0	26.7	55.0	5.0	1	30	1	250	
U0402FC36C	36.0	40.0	84.0	3.0	1	25	1	250	
Note: Maximum Leakage current < 5 μ A @ 2.8V for U0404FC3.3C, <500nA @ 3.3V for U0402FC05C and < 200nA @ 5V for U0402FC08C.									

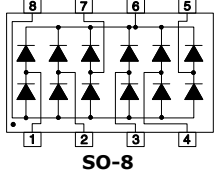
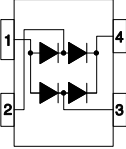
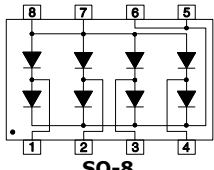
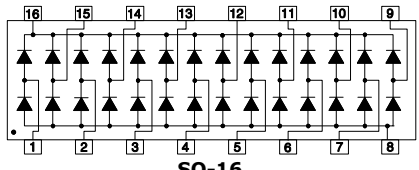
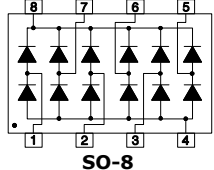
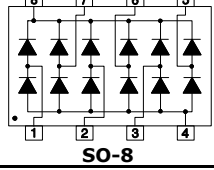
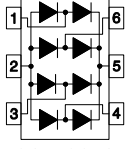
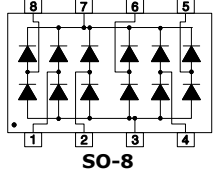
STEERING DIODES							
PART NUMBER	REPETITIVE PEAK REV. VOLT. - V_{RRM}	FORWARD PEAK PULSE CURRENT - A	FORWARD VOLTAGE V_F @ I_F	LEAKAGE CURRENT - μA @ V_{RRM}	CAPACITANCE C_j - pF	NUMBER OF LINES	PIN CONFIGURATION
DALC112S1	20.0	12.0	1.3 @ 50mA	0.02 @ 18V	5	6	 <p>SO-8</p>
DSL70	50.0	27.0	1.5 @ 1A	0.005	5	2	 <p>SOT-143</p>
ET108	25.0	12.0	9 @ 12A	2	6	4	 <p>SO-8</p>
ET720	30.0	12.0	2 @ 1A	0.02 @ 20V	3	14	 <p>SO-16</p>
ET721	50.0	12.0	2 @ 1A	0.02	3	6	 <p>SO-8</p>
ET723	20.0	12.0	2 @ 1A	0.02	5	6	 <p>SO-8</p>
ET724	20.0	12.0	2 @ 1A	0.01	3	4	 <p>SOT-23-6</p>
IO6LC	30.0	3.5	0.95 @ 20mA	0.1 @ 5.5V	3	6	 <p>SO-8</p>

STEERING DIODES							
PART NUMBER	REPETITIVE PEAK REV. VOLT. - V_{RRM}	FORWARD PEAK PULSE CURRENT - A	FORWARD VOLTAGE V_F @ I_F	LEAKAGE CURRENT - μA @ V_{RRM}	CAPACITANCE C_j - pF	NUMBER OF LINES	PIN CONFIGURATION
MAD1103	50.0	12.0	1.2 @ 100mA	0.1 @ 40V	5	8	<p>14 PIN DIP</p>
MAD1105	50.0	12.0	1.2 @ 100mA	0.1 @ 40V	5	8	<p>14 PIN DIP</p>
MAD1106	50.0	12.0	1.2 @ 100mA	0.1 @ 40V	5	8	<p>14 PIN DIP</p>
MAD1107	50.0	12.0	1.2 @ 100mA	0.1 @ 40V	5	8	<p>14 PIN DIP</p>
MAD1108	50.0	12.0	1.2 @ 100mA	0.1 @ 40V	5	8	<p>16 PIN DIP</p>
MAD1109	50.0	12.0	1.2 @ 100mA	0.1 @ 40V	5	7	<p>14 PIN DIP</p>
MMAD130	50.0	12.0	1.2 @ 100mA	0.1 @ 40V	5	8	<p>SO-14</p>
MMAD1103	50.0	12.0	1.2 @ 100mA	0.1 @ 40V	5	8	<p>SO-14</p>
MMAD1105	50.0	12.0	1.2 @ 100mA	0.1 @ 40V	5	8	<p>SO-14</p>
MMAD1106	50.0	12.0	1.2 @ 100mA	0.1 @ 40V	5	8	<p>SO-14</p>

STEERING DIODES							
PART NUMBER	REPETITIVE PEAK REV. VOLT. - V_{RRM}	FORWARD PEAK PULSE CURRENT - A	FORWARD VOLTAGE V_F @ I_F	LEAKAGE CURRENT - μA @ V_{RRM}	CAPACITANCE C_j - pF	NUMBER OF LINES	PIN CONFIGURATION
MMAD1107	50.0	12.0	1.2 @ 100mA	0.1 @ 40V	5	8	<p>SO-14</p>
MMAD1108	50.0	12.0	1.2 @ 100mA	0.1 @ 40V	5	8	<p>SO-16</p>
MMAD1109	50.0	12.0	1.2 @ 100mA	0.1 @ 40V	5	8	<p>SO-14</p>
PAM38DOAC10Y	1600	50	1.15 @ 1.5A	1	-	1	<p>DO-214AC</p>
PBYG10Y	1600	50	1.15 @ 1.5A	1	-	1	<p>DO-214AC</p>
PES1D	200	30	1.3 @ 1A	-	7	1	<p>DO-214AC</p>
PES1G	400	30	1.3 @ 1A	-	7	1	
PMAD1103	50.0	40.0	1.2 @ 100mA	0.1 @ 40V	5	8	<p>14 PIN DIP</p>
PMAD1105	50.0	40.0	1.2 @ 100mA	0.1 @ 40V	5	8	<p>14 PIN DIP</p>
PMAD1106	50.0	40.0	1.2 @ 100mA	0.1 @ 40V	5	8	<p>14 PIN DIP</p>
PMAD1108	50.0	40.0	1.2 @ 100mA	0.1 @ 40V	5	8	<p>16 PIN DIP</p>
PMAD1109	50.0	40.0	1.2 @ 100mA	0.1 @ 40V	5	7	<p>14 PIN DIP</p>

STEERING DIODES							
PART NUMBER	REPETITIVE PEAK REV. VOLT. - V_{RRM}	FORWARD PEAK PULSE CURRENT - A	FORWARD VOLTAGE V_F @ I_F	LEAKAGE CURRENT - μA @ V_{RRM}	CAPACITANCE C_j - pF	NUMBER OF LINES	PIN CONFIGURATION
PMMAD1103	50.0	40.0	1.2 @ 100mA	0.1 @ 40V	5	8	<p>SO-14</p>
PMMAD1106	50.0	40.0	1.2 @ 100mA	0.1 @ 40V	5	8	<p>SO-14</p>
PMMAD1108	50.0	40.0	1.2 @ 100mA	0.1 @ 40V	5	8	<p>SO-16</p>
PMMAD1109	50.0	40.0	1.2 @ 100mA	0.1 @ 40V	5	7	<p>SO-14</p>
PSRDA70-4	70.0	24.0	1.1 @ 100mA	5	6	4	<p>SO-8</p>
SR70	70.0	30.0	1.5 @ 1A	1	5	2	<p>SOT-143</p>
USB002	20.0	12.0	1.4 @ 10mA	1 @ 5V	0.6	2	<p>SOT-543</p>
USB004	20.0	12.0	0.95 @ 20mA	1 @ 5V	6.0	2	<p>SOT-143</p>
USB208	20.0	12.0	1.2 @ 50mA	1 @ 5V	5	4	<p>SOT-23-6</p>

EMI FILTER/TVS ARRAYS								
PART NUMBER	STAND-OFF VOLTAGE - V_{WM}	MIN. BREAKDOWN VOLTAGE - V_{BR} @ 1 mA	REVERSE LEAKAGE CURRENT - μA @ V_{WM}	RESISTANCE $\pm 20\%$ - OHMS	CUT-OFF FREQUENCY - MHZ (50 Ohm System)	CAPACITANCE C_T - pF	NUMBER OF LINES	PIN CONFIGURATION
EM02-100	5.0	6.0	0.1	100	110	30	2	<p>SOT-563</p>
EM1631-08DSL	5.0	6.0	0.1	100	110	30	8	<p>For Each Line 100 Ohm 15pF 15pF</p> <p>I/O n I/O n</p> <p>GND</p> <p>I/O connected from pins 1-16, 2-15, 3-14, 4-13, 5-12, 6-11, 7-10 and 8-9.</p> <p>DFN-16SLP</p>
EM4D-100L	5.0	6.0	0.1 @ 3V	100	150	20	4	<p>100 Ohm 10pF 10pF</p> <p>I/O n I/O n</p> <p>GND</p> <p>DFN-8/LP</p>
EM4DLP-100L	5.0	6.0	0.1 @ 3V	100	150	20	4	
EM8D-100L	5.0	6.0	0.1 @ 3V	100	150	20	8	<p>100 Ohm 10pF 10pF</p> <p>I/O n I/O n</p> <p>GND</p> <p>DFN-16/LP/SLP</p>
EM8DLP-100L	5.0	6.0	0.1 @ 3V	100	150	20	8	
EM8DSPL-100L	5.0	6.0	0.1 @ 3V	100	150	20	8	
EM8Q-100	5.0	6.0	0.1 @ 3V	100	150	20	8	<p>I/O 1 Pin 2 D1 I/O 2 Pin 1 R2 I/O 3 Pin 16 I/O 4 Pin 15 R4</p> <p>Pin 3 Pin 4 Pin 5 Pin 6</p> <p>I/O 5 Pin 14 D1 I/O 6 Pin 13 R6 I/O 7 Pin 12 I/O 8 Pin 11 R8</p> <p>Pin 7 Pin 8 Pin 9 Pin 10</p> <p>Center tab as the ground</p> <p>QFN-16</p>
STF701	5.0	6.0	1.0 @ 3.3V	-	-	160	2	<p>IN 1 1 5 OUT 1</p> <p>GND 2</p> <p>IN 2 3 4 OUT 2</p> <p>SC70-5L</p>

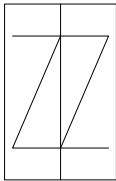

THYRISTOR SURGE SUPPRESSORS



PART NUMBER	REPETITIVE PEAK OFF-STATE VOLTAGE - V_{DRM}	SWITCHING VOLTAGE - V_s	MINIMUM HOLDING CURRENT - mA I_H	SWITCHING CURRENT - mA I_S	MAX. OFF-STATE CURRENT - μA @ V_{DRM}	MAX. ON-STATE VOLTAGE - V_T	ON-STATE CURRENT - A I_T	CAPACITANCE C_T - pF	PIN CONFIGURATION
PP0080SA	6	25	50	800	5	4	2.2	50	 <p>DO-214AA</p>
PP0300SA	25	40	50	800	5	4	2.2	60	
PP0640SA	58	77	150	800	5	4	2.2	60	
PP0720SA	65	88	150	800	5	4	2.2	60	
PP0800SA	75	98	150	800	5	4	2.2	60	
PP1100SA	90	130	150	800	5	4	2.2	60	
PP1300SA	120	160	150	800	5	4	2.2	40	
PP1500SA	140	180	150	800	5	4	2.2	40	
PP1800SA	160	220	150	800	5	4	2.2	40	
PP2300SA	190	260	150	800	5	4	2.2	30	
PP2600SA	220	300	150	800	5	4	2.2	30	
PP3100SA	275	350	150	800	5	4	2.2	30	
PP3500SA	300	400	150	800	5	4	2.2	30	
PP0080SB	6	25	50	800	5	4	2.2	60	
PP0300SB	25	40	50	800	5	4	2.2	110	
PP0640SB	58	77	150	800	5	4	2.2	60	
PP0720SB	65	88	150	800	5	4	2.2	60	
PP0800SB	75	98	150	800	5	4	2.2	60	
PP1100SB	90	130	150	800	5	4	2.2	60	
PP1300SB	120	160	150	800	5	4	2.2	40	
PP1500SB	140	180	150	800	5	4	2.2	40	
PP1800SB	160	220	150	800	5	4	2.2	40	
PP2300SB	190	260	150	800	5	4	2.2	30	
PP2600SB	220	300	150	800	5	4	2.2	30	
PP3100SB	275	350	150	800	5	4	2.2	30	
PP3500SB	300	400	150	800	5	4	2.2	30	
PP0080SC	6	25	50	800	5	4	2.2	30	
PP0300SC	25	40	50	800	5	4	2.2	60	
PP0640SC	58	77	150	800	5	4	2.2	120	
PP0720SC	65	88	150	800	5	4	2.2	120	
PP0800SC	75	98	150	800	5	4	2.2	120	
PP1100SC	90	130	150	800	5	4	2.2	120	
PP1300SC	120	160	150	800	5	4	2.2	80	
PP1500SC	140	180	150	800	5	4	2.2	80	
PP1800SC	160	220	150	800	5	4	2.2	80	
PP2300SC	190	260	150	800	5	4	2.2	60	
PP2600SC	220	300	150	800	5	4	2.2	60	
PP3100SC	275	350	150	800	5	4	2.2	60	
PP3500SC	300	400	150	800	5	4	2.2	60	

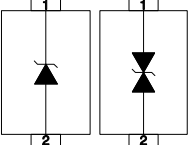
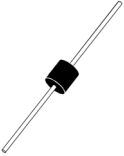
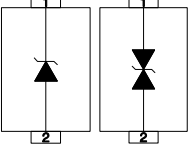
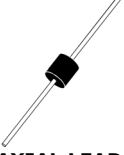
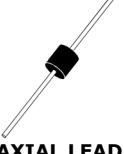
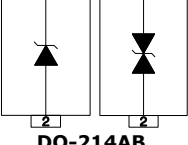

SURGE RATINGS								
SERIES	I_{PP} 2 X 10 μ s AMPS	I_{PP} 8 X 20 μ s AMPS	I_{PP} 10 X 160 μ s AMPS	I_{PP} 10 X 560 μ s AMPS	I_{PP} 10 X 1000 μ s AMPS	I_{RSM} 60 Hz AMPS	di/dt AMPS/ μ s (Note 1)	dv/dt V/ μ s (Note 1)
SA	150	150	100	50	50	20	500	2000
SB	300	300	150	100	80	32	500	2000
SC	500	400	200	200	100	60	500	2000

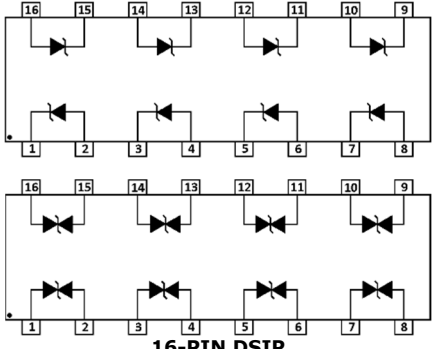
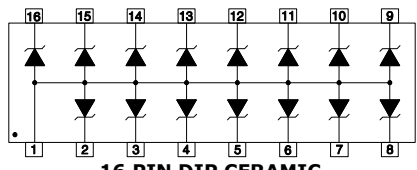
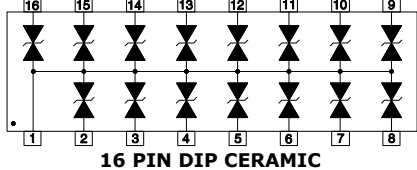

Note 1: Critical Rate of Rise for On-State Current (di/dt) and Off-State Voltage (dv/dt).

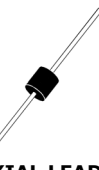
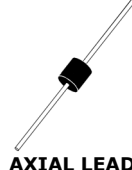
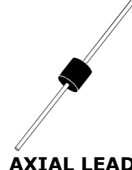
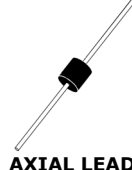

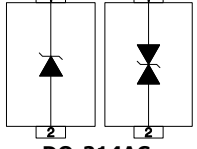
THYRISTOR SURGE SUPPRESSORS									
PART NUMBER	REPETITIVE PEAK OFF-STATE VOLTAGE - V_{DRM}	SWITCHING VOLTAGE - V_s	MINIMUM HOLDING CURRENT - I_H mA	SWITCHING CURRENT - I_S mA	MAX. OFF-STATE CURRENT - μA @ V_{DRM}	MAX. ON-STATE VOLTAGE - V_T	ON-STATE CURRENT - I_T A	CAPACITANCE C_T - pF	PIN CONFIGURATION
PSLIC1	170	-	150	-	5	-	30	70	<p>SO-8</p>
PSMP30-240	240	-	150	-	-	-	3A @ 15 min	10	<p>DO-214AC</p>

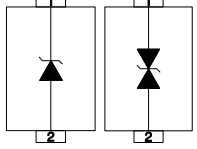
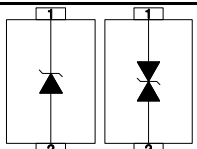
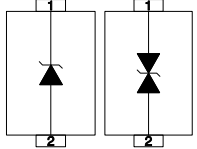
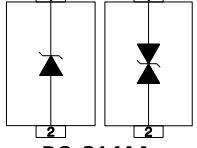
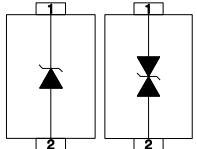
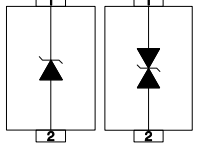
HIGH POWERED COMPONENTS							
PART NUMBER	STAND-OFF VOLTAGE - V_{WM}	MIN. BREAKDOWN VOLTAGE - V_{BR}	CLAMPING VOLTAGE - V_c	CURRENT I_{pp} @ 10/1000 μ s - A	LEAKAGE CURRENT - μ A @ V_{WM}	POWER @ 10/1000 μ s - W	
1.0SMBJ5.0A	5.0	6.40	9.2	108.7	200	1000	<p style="text-align: center;">PACKAGE</p>  <p style="text-align: center;">DO-214AA</p>
Not all voltages show for the 1.0SMBJ Series. Please consult the factory for other voltages.							
1.0SMBJ200A	200.0	224.0	324.0	3.1	1	1000	
Note: Part numbers shown are unidirectional devices. Add a "CA" suffix to specify bidirectional devices, such as '1.0SMBJ15CA'.							
1.5KE6.8	5.8	6.46	10.5	143	1000	1500	 <p style="text-align: center;">AXIAL LEAD</p>
Not all voltages show for the 1.5KE Series. Please consult the factory for other voltages.							
1.5KE600A	513.0	570.0	828.0	1.8	1	1500	
Note: Part numbers shown are unidirectional devices. Add a "CA" suffix to specify bidirectional devices, such as '1.5KE520CA'.							
1.5SMC6.8A	5.8	6.45	10.5	144.8	1000	1500	 <p style="text-align: center;">DO-214AB</p>
Not all voltages show for the 1.5SMC Series. Please consult the factory for other voltages.							
1.5SMC550A	495.0	522.5	760.0	2.0	1	1500	
Note: Part numbers shown are unidirectional devices. Add a "CA" suffix to specify bidirectional devices, such as '1.5SMC6.8CA'.							
15KPA17A	17.0	18.9	29.3	512.0	5000	15000	 <p style="text-align: center;">AXIAL LEAD</p>
Not all voltages show for the 15KPA Series. Please consult the factory for other voltages.							
15KPA280A	280.0	311.0	452.0	33.0	2	15000	
Note: Part numbers shown are unidirectional devices. Add a "CA" suffix to specify bidirectional devices, such as '15KPA17CA'.							
30KPA28A	28.0	31.3	50.0	606.0	5000	30000	 <p style="text-align: center;">AXIAL LEAD</p>
Not all voltages show for the 30KPA Series. Please consult the factory for other voltages.							
30KPA400A	400.0	440.0	704.0	42.6	2	30000	
Note: Part numbers shown are unidirectional devices. Add a "CA" suffix to specify bidirectional devices, such as '30KPA400CA'.							
5.0SMDJ6.0CA	6.0	6.67	10.3	485	2000	5000	 <p style="text-align: center;">DO-214AB</p>
Not all voltages show for the 5.0SMDJ Series. Please consult the factory for other voltages.							
5.0SMDJ440A	440.0	492.0	713.0	7.0	5	5000	
Note: Part numbers shown are unidirectional devices. Add a "CA" suffix to specify bidirectional devices, such as '5.0SMDJ440CA'.							
5KP5.0A	5.0	6.4	9.2	543	5000	5000	 <p style="text-align: center;">AXIAL LEAD</p>
Not all voltages show for the 5KP Series. Please consult the factory for other voltages.							
5KP440A	440.0	492.0	713.0	7.0	2	5000	
Note: Part numbers shown are unidirectional devices. Add a "CA" suffix to specify bidirectional devices, such as '5KP180CA'.							

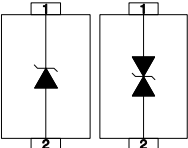
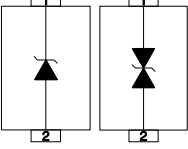
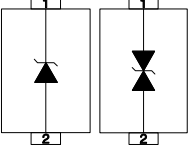
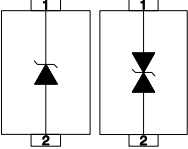
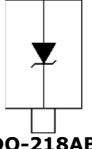
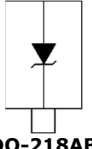
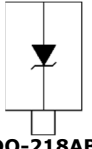
HIGH POWERED COMPONENTS							PACKAGE
PART NUMBER	STAND-OFF VOLTAGE - V_{WM}	MIN. BREAKDOWN VOLTAGE - V_{BR}	CLAMPING VOLTAGE - V_c	CURRENT I_{pp} @10/1000 μ s - A	LEAKAGE CURRENT - μ A @ V_{WM}	POWER @ 10/1000 μ s - W	
DD3K06CA	6.0	6.67	10.3	291.3	1000	3000	 <p>16-PIN DSIP</p>
DD3K09CA	9.0	10.0	15.4	194.8	10	3000	
DD3K12CA	12.0	13.3	19.9	150.6	5	3000	
DD3K18CA	18.0	20.0	29.2	102.8	2	3000	
DD3K30A	30.0	33.3	48.4	62.0	2	3000	
DD3K40A	40.0	44.4	64.5	46.4	2	3000	
DLZ-5	5.0	6.0	12.5	10.0	200	1300 8/20 μ s	 <p>16 PIN DIP CERAMIC</p>
DLZ-5A	5.0	6.0	10.6	10.0	200		
DLZ-12	12.0	13.3	26.0	10.0	2		
DLZ-12A	12.0	13.3	23.5	10.0	2		
DLZ-17	17.0	19.2	37.4	10.0	2		
DLZ-17A	17.0	19.2	33.9	10.0	2		
DLZ-24	24.0	26.7	52.1	10.0	2		
DLZ-24A	24.0	26.7	47.2	10.0	2		
DLZ-30	30.0	33.3	65.0	10.0	2		
DLZ-30A	30.0	33.3	58.8	10.0	2		
DLZ-8C	8.0	8.5	16.6	10.0	10	1300 8/20 μ s	 <p>16 PIN DIP CERAMIC</p>
DLZ-13C	13.0	14.4	28.1	10.0	4		
DLZ-13CA	13.0	14.4	25.4	10.0	4		
DLZ-19C	19.0	21.6	42.1	10.0	4		
DLZ-19CA	19.0	21.6	38.1	10.0	4		
DLZ-30C	30.0	33.3	65.0	10.0	4		
DLZ-30CA	30.0	33.3	58.8	10.0	4		
K1-076	54.0	83.0	135.0	-	20	-	 <p>AXIAL LEAD</p>
Not all voltages show for the K Series. Please consult the factory for other voltages.							
KD-076	54.0	85.0	145.0	-	20	-	 <p>AXIAL LEAD</p>
Note: K1, KA, KB, Kc and KD Series is available. Please consult factory for more information.							
P15KP17	17.0	18.9	32.3	464.0	5000	15000	 <p>AXIAL LEAD</p>
Not all voltages show for the P15KP Series. Please consult the factory for other voltages.							
P15KP280A	280.0	311.0	452.0	33.0	10	15000	
P30KP30A	30.0	33.3	55.2	543.0	5000	30000	
Not all voltages show for the P30KP Series. Please consult the factory for other voltages.							
P30KP260A	260.0	289.0	416.0	72.0	10	30000	 <p>AXIAL LEAD</p>
Note: Part numbers shown are unidirectional devices. Add a "CA" suffix to specify bidirectional devices, such as 'P15KP17CA'.							
P4KE22A	18.8	20.9	30.6	13.1	1	400	 <p>AXIAL LEAD</p>
P4KE36A	30.8	34.2	49.9	8.2	1	400	
Note: Part numbers shown are unidirectional devices. Add a "CA" suffix to specify bidirectional devices, such as 'P4KE522CA'.							

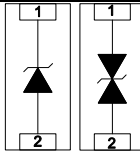
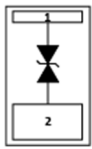
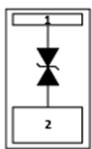

HIGH POWERED COMPONENTS							
PART NUMBER	STAND-OFF VOLTAGE - V_{WM}	MIN. BREAKDOWN VOLTAGE - V_{BR}	CLAMPING VOLTAGE - V_c	CURRENT I_{pp} @10/1000 μ s - A	LEAKAGE CURRENT - μ A @ V_{WM}	POWER @ 10/1000 μ s - W	
P4SMA13A	11.1	12.4	18.2	22.5	1	400	 <p>DO-214AC</p>
Not all voltages show for the P4SMA Series. Please consult the factory for other voltages.							
P4SMA550A	470.3	522.5	759.0	0.53	1	400	
Note: Part numbers shown are unidirectional devices. Add a "CA" suffix to specify bidirectional devices, such as 'P4SMA130CA'.							
P6KE6.8	5.5	6.46	10.5	57.1	1000	600	 <p>AXIAL LEAD</p>
Not all voltages show for the P6KE Series. Please consult the factory for other voltages.							
P6KE600A	513.0	570.0	828.0	0.7	1	600	
Note: Part numbers shown are unidirectional devices. Add a "CA" suffix to specify bidirectional devices, such as 'P6KE520CA'.							
P6SMB6.8A	5.8	6.46	10.5	57.14	1000	600	 <p>DO-214AA</p>
Not all voltages show for the P6SMB Series. Please consult the factory for other voltages.							
P6SMB600A	513	570	828.0	0.72	1	600	
Note: Part numbers shown are unidirectional devices. Add a "CA" suffix to specify bidirectional devices, such as 'P6SMB600CA'.							
PAM28DOAC6.5A	6.5	7.22	11.2	35.7	500	400	 <p>DO-214AC</p>
Not all voltages show for the PAM28 Series. Please consult the factory for other voltages.							
PAM28DOAC120A	120.0	133.0	193.0	2.1	1	400	
Note: Part numbers shown are unidirectional devices. Add a "CA" suffix to specify bidirectional devices, such as 'PAM28DOAC6.5CA'.							
PAM29DOAA5.0A	5.0	6.40	9.2	65.2	800	600	 <p>DO-214AA</p>
Not all voltages show for the PAM29 Series. Please consult the factory for other voltages.							
PAM29DOAA180A	180.0	200.0	291.6	2.1	1	600	
Note: Part numbers shown are unidirectional devices. Add a "CA" suffix to specify bidirectional devices, such as 'PAM29DOAA180CA'.							
PAM30DOAA6.8A	5.8	6.46	10.5	57.14	1000	600	 <p>DO-214AA</p>
Not all voltages show for the PAM30 Series. Please consult the factory for other voltages.							
PAM30DOAA600A	513	570	828.0	0.72	1	600	
Note: Part numbers shown are unidirectional devices. Add a "CA" suffix to specify bidirectional devices, such as 'PAM30DOAA600CA'.							
PAM31DOAB13A	13.0	14.4	21.5	69.8	1	1500	 <p>DO-214AB</p>
Not all voltages show for the PAM31 Series. Please consult the factory for other voltages.							
PAM31DOAB170A	170.0	189.0	275.0	5.5	1	1500	
Note: Part numbers shown are unidirectional devices. Add a "CA" suffix to specify bidirectional devices, such as 'PAM31DOAB18CA'.							
PAM32DOAB12A	12.0	13.3	19.9	151	2	3000	 <p>DO-214AB</p>
Not all voltages show for the PAM32 Series. Please consult the factory for other voltages.							
PAM32DOAB36A	36.0	40.0	58.1	51.6	2	3000	
Note: Part numbers shown are unidirectional devices. Add a "CA" suffix to specify bidirectional devices, such as 'PAM32DOAB36CA'.							

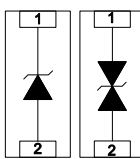
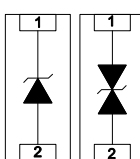
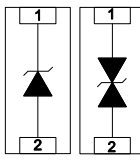
HIGH POWERED COMPONENTS								
PART NUMBER	STAND-OFF VOLTAGE - V_{WM}	MIN. BREAKDOWN VOLTAGE - V_{BR}	CLAMPING VOLTAGE - V_c	CURRENT I_{PP} @ 10/1000 μ s - A	LEAKAGE CURRENT - μ A @ V_{WM}	POWER @ 10/1000 μ s - W		
PAM33DOAB14A	14.0	15.6	23.2	218	200	5000	 <p>DO-214AB</p>	
Not all voltages show for the PAM33 Series. Please consult the factory for other voltages.								
PAM33DOAB180A	180.0	200.0	291.6	17.3	5	5000		
Note: Part numbers shown are unidirectional devices. Add a "CA" suffix to specify bidirectional devices, such as 'PAM33DOAB180CA'.								
PAM35DOAB6.8A	5.8	6.45	10.5	144.8	1000	1500	 <p>DO-214AB</p>	
Not all voltages show for the PAM35 Series. Please consult the factory for other voltages.								
PAM35DOAB300A	256.0	285.0	414.0	3.7	1	1500		
Note: Part numbers shown are unidirectional devices. Add a "CA" suffix to specify bidirectional devices, such as 'PAM35DOAB30CA'.								
PAM36DOAA18A	18.0	20.0	29.2	34.3	1	1000	 <p>DO-214AA</p>	
Not all voltages show for the PAM36 Series. Please consult the factory for other voltages.								
PAM36DOAA36A	36.0	40.0	58.1	17.3	1	600		
Note: Part numbers shown are unidirectional devices. Add a "CA" suffix to specify bidirectional devices, such as 'PAM36DOAA36CA'.								
PAM4SMA13A	11.1	12.4	18.2	22.5	1	400	 <p>DO-214AC</p>	
Not all voltages show for the PAM4SMA Series. Please consult the factory for other voltages.								
PAM4SMA550A	470.3	522.5	759.0	0.53	1	400		
Note: Part numbers shown are unidirectional devices. Add a "CA" suffix to specify bidirectional devices, such as 'PAM4SMA550CA'.								
PAM5S14A	14.0	15.6	23.2	155	10	3600	 <p>DO-218AB</p>	
Not all voltages show for the PAM5S Series. Please consult the factory for other voltages.								
PAM5S36A	36.0	40.0	58.1	62.0	10	3600		
PAM6S14A	14.0	15.6	23.2	198	10	4600	 <p>DO-218AB</p>	
Not all voltages show for the PAM6S Series. Please consult the factory for other voltages.								
PAM6S36A	36.0	40.0	58.1	79	10	4600		
PAM8S14A	14.0	15.6	23.2	284	10	6600	 <p>DO-218AB</p>	
Not all voltages show for the PAM8S Series. Please consult the factory for other voltages.								
PAM8S48A	48.0	53.3	85.2	77.4	10	6600		
PDTV58CA	58.0	64.0	110	3kA	10	-	 <p>2-LEAD ENCAPSULATED COMPONENT</p>	
PDTV576CA	76.0	85.0	140	3kA	10	-		

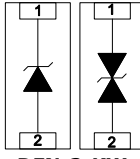
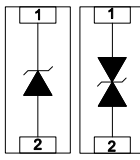
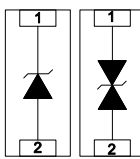
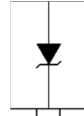
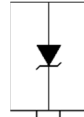
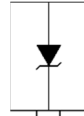
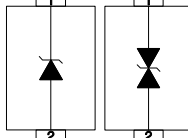
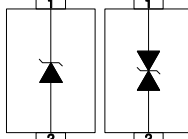
HIGH POWERED COMPONENTS							
PART NUMBER	STAND-OFF VOLTAGE - V_{WM}	MIN. BREAKDOWN VOLTAGE - V_{BR}	CLAMPING VOLTAGE - V_C	CURRENT I_{PP} @ 10/1000 μ s - A	LEAKAGE CURRENT - μ A @ V_{WM}	POWER @ 10/1000 μ s - W	PACKAGE
PHS503	3.3	4.0	6.5	1.0	125	400-500 8/20 μ s	 DFN-2
Not all voltages show for the PHS5xx Series. Please consult the factory for other voltages.							
PHS536	36.0	40.0	60.0	1.0	1.	400-500 8/20 μ s	
Note: Part numbers shown are unidirectional devices. Add a "CA" suffix to specify bidirectional devices, such as 'PHS503C'.							
PHYTVS125V3	125	220	130	250	10	250 8/20 μ s	 DFN-2KW
PHYTVS250V3	250	420	230	250	10		
PHYTVS277V3	277	440	250	250	10		
PHYTVS125V4	125	220	130	500	10	500 8/20 μ s	 DFN-2KW
PHYTVS250V3	250	420	230	500	10		
PHYTVS277V3	277	440	250	500	10		
SKC-058CS	58.0	64.0	110.0	10000	10	1600kW 8/20 μ s	 SMT0-218T
SKC-066CS	66.0	72.0	120	10000	10		
SKC-076CS	76.0	85.0	140	10000	10		
SKC-086CS	86.0	95.0	157	10000	10		
SM10KW10A	10.0	11.1	20.0	3000	15	8500	 DFN-2-KW
SM10KW12A	12.0	13.4	24.0	2500	8	8500	
SM10KW15A	15.0	16.5	30.0	2000	8	8500	
SM10KW22A	22.0	24.4	40.2	1492	8	8500	
SM10KW24A	24.0	26.8	48.3	1242	8	8500	
SM10KW28A	28.0	31.2	56.1	1069	8	8500	
SM10KW30A	30.0	33.5	60.3	995	8	8500	
SM10KW33A	33.0	36.8	66.0	909	8	8500	
SM10KW36A	36.0	40.0	72.3	829	8	8500	
Note: Part numbers shown are unidirectional. Add a "C" suffix to specify bidirectional devices, such as 'SM10KW36CA'.							
SM10KWE10A	10.0	11.1	17.0	588	15	10000	 DFN-2-KW
SM10KWE12A	12.0	13.4	19.9	502	8	10000	
SM10KWE22A	22.0	24.4	36.5	282	8	10000	
SM10KWE24A	24.0	26.8	38.9	258	8	10000	
SM10KWE28A	28.0	31.2	45.4	220	8	10000	
SM10KWE30A	30.0	33.5	48.4	206	8	10000	
SM10KWE33A	33.0	36.8	53.3	187	8	10000	
SM10KWE36A	36.0	40.0	58.1	172	8	10000	
SM10KWE48A	48.0	53.0	77.4	129	8	10000	
Note: Part numbers shown are unidirectional. Add a "C" suffix to specify bidirectional devices, such as 'SM10KWE36CA'.							
SM15KWE15A	15.0	16.9	24.4	618	10	15000	 DFN-2-KW
Not all voltages show for the SM15KWE Series. Please consult the factory for other voltages.							
SM15KWE120A	133.0	147.0	193.0	78.0	5	15000	
Note: Part numbers shown are unidirectional. Add a "C" suffix to specify bidirectional devices, such as 'SM15KWE36CA'.							

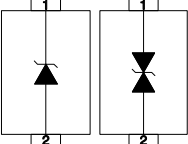
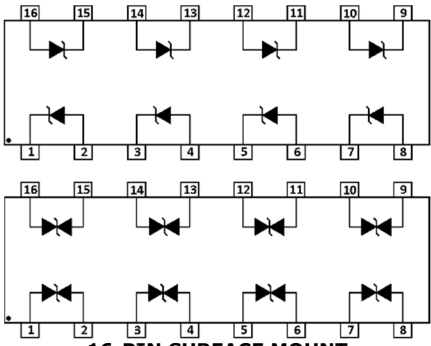
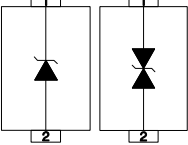
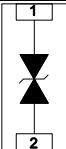
HIGH POWERED COMPONENTS								
PART NUMBER	STAND-OFF VOLTAGE - V_{WM}	MIN. BREAKDOWN VOLTAGE - V_{BR}	CLAMPING VOLTAGE - V_c	CURRENT I_{pp} @ 10/1000 μ s - A	LEAKAGE CURRENT - μ A @ V_{WM}	POWER @ 10/1000 μ s - W	PACKAGE	
SM30KWE16A	16.0	17.8	26.0	1150	100	30000	 DFN-2-KW	
Not all voltages show for the SM30KWE Series. Please consult the factory for other voltages.								
SM30KWE120A	133.0	147.0	193.0	156.0	5	30000		
Note: Part numbers shown are unidirectional. Add a "C" suffix to specify bidirectional devices, such as 'SM30KWE36CA'.								
SM3KW08A	8.0	8.8	13.6	220.0	50	3000	 DFN-2-KW	
Not all voltages show for the SM3KW Series. Please consult the factory for other voltages.								
SM3KW33A	33	36.7	56.3	53.3	2	3000		
Note: Part numbers shown are unidirectional. Add a "C" suffix to specify bidirectional devices, such as 'SM3KW08CA'.								
SM3KW10A	10.0	11.1	17.0	296.0	15	5000	 DFN-2-KW	
Not all voltages show for the SM5KW Series. Please consult the factory for other voltages.								
SM5KW36A	36.0	40.2	58.1	86.0	8	5000		
Note: Part numbers shown are unidirectional. Add a "C" suffix to specify bidirectional devices, such as 'SM5KW10CA'.								
SM5S14A	14.0	15.6	23.2	155	10	3600	 DO-218AB	
Not all voltages show for the SM5S Series. Please consult the factory for other voltages.								
SM5S36A	36.0	40.0	58.1	62.0	10	3600		
SM6S14A	14.0	15.6	23.2	198	10	4600	 DO-218AB	
Not all voltages show for the SM6S Series. Please consult the factory for other voltages.								
SM6S36A	36.0	40.0	58.1	79	10	4600		
SM8S14A	14.0	15.6	23.2	284	10	6600	 DO-218AB	
Not all voltages show for the SM8S Series. Please consult the factory for other voltages.								
SM8S48A	48.0	53.3	85.2	77.4	10	6600		
SMAJ5.0A	5.0	6.4	9.2	43.5	800	400	 DO-214AC	
Not all voltages show for the SMAJ Series. Please consult the factory for other voltages.								
SMAJ440A	440.0	492.0	713.0	0.6	1	400		
Note: Part numbers shown are unidirectional devices. Add a "CA" suffix to specify bidirectional devices, such as 'SMAJ440CA'.								
SMBJ5.0A	5.0	6.4	9.2	65.2	800	600	 DO-214AA	
Not all voltages show for the SMBJ Series. Please consult the factory for other voltages.								
SMBJ480A	480.0	537.0	779.0	0.77	1	600		
Note: Part numbers shown are unidirectional devices. Add a "CA" suffix to specify bidirectional devices, such as 'SMBJ480CA'.								

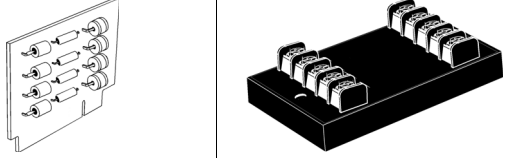
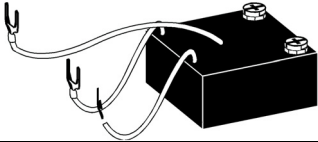
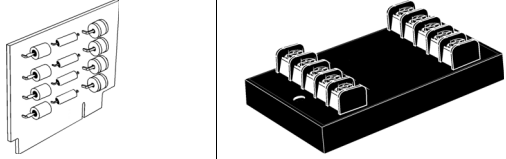
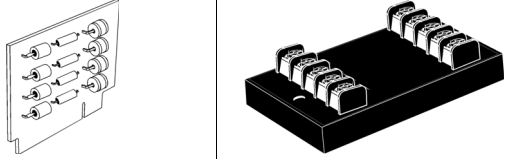
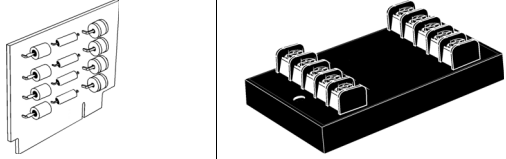
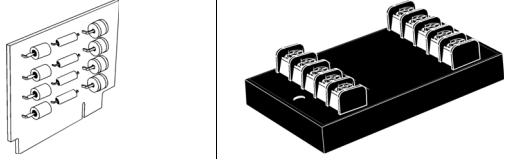
HIGH POWERED COMPONENTS							PACKAGE
PART NUMBER	STAND-OFF VOLTAGE - V_{WM}	MIN. BREAKDOWN VOLTAGE - V_{BR}	CLAMPING VOLTAGE - V_c	CURRENT I_{pp} @10/1000 μ s - A	LEAKAGE CURRENT - μ A @ V_{WM}	POWER @ 10/1000 μ s - W	
SMCJ5.0A	5.0	6.4	9.2	163.0	800	1500	 <p>DO-214AB</p>
Not all voltages show for the SMCJ Series. Please consult the factory for other voltages.							
SMCJ440A	440.0	492.0	713.3	2.1	1	1500	
Note: Part numbers shown are unidirectional devices. Add a "CA" suffix to specify bidirectional devices, such as 'SMCJ440CA'.							
SMDD3K06CA	6.0	6.67	10.3	291.3	1000	3000	 <p>16-PIN SURFACE MOUNT</p>
SMDD3K09CA	9.0	10.0	15.4	194.8	10	3000	
SMDD3K12CA	12.0	13.3	19.9	150.6	5	3000	
SMDD3K18CA	18.0	20.0	29.2	102.8	2	3000	
SMDD3K30A	30.0	33.3	48.4	62.0	2	3000	
SMDD3K40A	40.0	44.4	64.5	46.4	2	3000	
SMDJ5.0A	5.0	6.4	9.2	326	5000	3000	 <p>DO-214AB</p>
Not all voltages show for the SMDJ Series. Please consult the factory for other voltages.							
SMDJ440A	440.0	492.0	713.3	4.2	2	3000	
Note: Part numbers shown are unidirectional devices. Add a "CA" suffix to specify bidirectional devices, such as 'SMDJ440CA'.							
SMEJ48CA	48.0	53.3	92	3kA	-	 <p>2L-ENCAPSULATED</p>	
SMEJ58CA	58.0	64.0	110	3kA	-		
SMEJ66CA	66.0	72.0	120	3kA	-		
SMEJ76CA	76.0	85.0	140	3kA	-		

HIGH POWERED MODULES							PACKAGE	
PART NUMBER	STAND-OFF VOLTAGE - V_{WM}	CLAMPING VOLTAGE - V_c @ 8/20 μ s	MAX. CURRENT @ 8/20 μ s - kA/Line	LEAKAGE CURRENT - μ A @ V_{WM}	SERIES RESISTANCE OHMS	CAPACITANCE pF		
232B	± 25	40.0 @ 500A	10	5	12	2000		
232E	± 25	40.0 @ 500A	10	5	12	2000		
Note: Lines of protection: 2 pair.								
420E212	± 12.0	22.0 @ 2kA	10	5	12	6000		
420E225	± 25.0	44.0 @ 2kA	10	5	12	3000		
420E228	± 28.0	46.0 @ 2kA	10	5	12	2800		
420E236	± 36.0	60.0 @ 2kA	10	5	12	1500		
420E250	± 50.0	80.0 @ 2kA	10	5	12	1200		
420E260	± 60.0	95.0 @ 2kA	10	5	12	1000		
Note: Lines of protection: 1 pair.								
420LB28	± 28.0	40.0 @ 2kA	10	5	12	2800		
420LB35	± 35.0	60.0 @ 2kA	10	5	12	1500		
420LB60	± 60.0	85.0 @ 2kA	10	5	12	1000		
420LE28	± 28.0	40.0 @ 2kA	10	5	12	2800		
420LE35	± 35.0	60.0 @ 2kA	10	5	12	1500		
420LE60	± 60.0	85.0 @ 2kA	10	5	12	1000		
Note: Lines of protection: 2 pair.								
422B	± 12.0	24.0 @ 500A	10	5	12	5000		
422E	± 12.0	24.0 @ 500A	10	5	12	5000		
Note: Lines of protection: 2 pair.								
422ELC	± 12.0	30.0 @ 500A	10	1	12	25		
485ELC	± 7.0	20.0 @ 500A	10	10	12	25		
Note: Lines of protection: 2 pair.								
587B051	130.0 AC	350.0	3	1mA	-	-		
587B151	130.0 AC	350.0	3	1mA	-	-		
587B201	130.0 AC	350.0	3	1mA	-	-		
587B301	130.0 AC	350.0	3	1mA	-	-		
Note: Maximum Line Current: 5A, 15A, 20A, 30. Line to Neutral.								
587B062	240.0 AC	800.0	3	1mA	-	-		
587B162	240.0 AC	800.0	3	1mA	-	-		
587B302	240.0 AC	800.0	3	1mA	-	-		
Note: Maximum Line Current: 6A, 16A, 30A. Line to Neutral.								
587B051LP	120.0 AC	330.0	3	1mA	-	-		
587B101LP	120.0 AC	330.0	3	1mA	-	-		
587B151LP	120.0 AC	330.0	3	1mA	-	-		
587B301LP	120.0 AC	330.0	3	1mA	-	-		
Note: Maximum Line Current: 5A, 10A, 15A, 30A. Line to Neutral.								
587B062LP	240.0 AC	800.0	3	1mA	-	-		
587B102LP	240.0 AC	800.0	3	1mA	-	-		
587B162LP	240.0 AC	800.0	3	1mA	-	-		
587B302LP	240.0 AC	800.0	3	1mA	-	-		
Note: Maximum Line Current: 6A, 10A, 16A, 30A. Line to Neutral.								
587B062LPE	240.0 AC	800.0	3	1mA	-	-		
587B102LPE	240.0 AC	800.0	3	1mA	-	-		
587B162LPE	240.0 AC	800.0	3	1mA	-	-		
587B302LPE	240.0 AC	800.0	3	1mA	-	-		
Note: Maximum Line Current: 6A, 10A, 16A, 30A. Line to Neutral.								
PHCR660-1.0	440.0	1000	1	5	5	-		
PHCR880-1.0	660.0	1300	1	5	5	-		
PHCR660-2.5	440.0	1000	2.5	5	5	-		
PHCR880-2.5	660.0	1250	2.5	5	5	-		
PHCR660-5	440.0	1000	5	5	5	-		
PHCR880-5	660.0	1250	5	5	5	-		
PHCR660-10	440.0	1000	10	5	5	-		
PHCR880-10	660.0	1250	10	5	5	-		

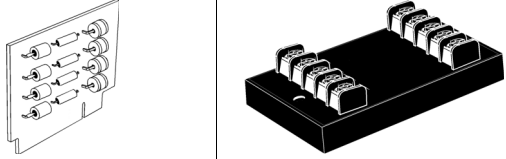
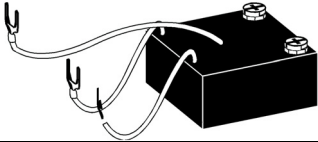
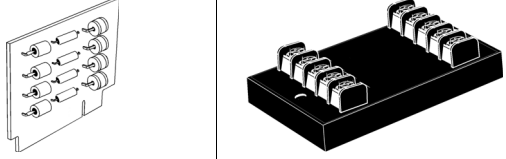

LP & LPE

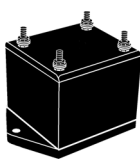

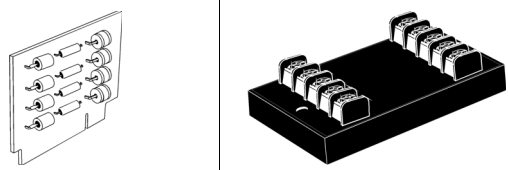
HIGH POWERED MODULES							PACKAGE
PART NUMBER	STAND-OFF VOLTAGE - V_{WM}	CLAMPING VOLTAGE - V_c @ 8/20 μ S	MAX. CURRENT @ 8/20 μ s - kA/Line	LEAKAGE CURRENT - μ A @ V_{WM}	SERIES RESISTANCE OHMS	CAPACITANCE pF	
TEL50B	± 50.0	95.0 @ 500A	10	5	12	800	
TEL50E	± 50.0	95.0 @ 500A	10	5	12	800	
TEL185B	± 185.0	330.0 @ 500A	10	5	12	800	
TEL185E	± 185.0	330.0 @ 500A	10	5	12	800	

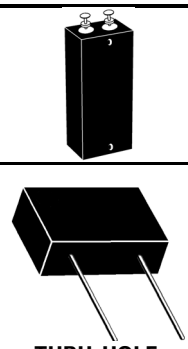
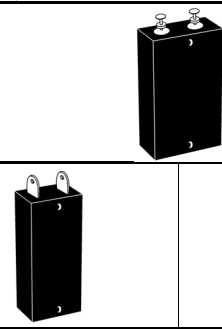
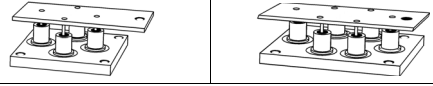

Note: Lines of protection: 2 pair.

HIGH POWERED MODULES							PACKAGE
PART NUMBER	STAND-OFF VOLTAGE - V_{WM}	MIN. BREAKDOWN VOLTAGE - V_{BR}	CLAMPING VOLTAGE - V_c	CURRENT I_{PP} @ 10/1000 μ s - A	LEAKAGE CURRENT - μ A @ V_{WM}	POWER @ 10/1000 μ s - kW	
100KS200CNH	180.0	200.0	335.0	300	0.5	100kW	
15KP17	17.0	18.9	32.3	464.0	5000	15	
Not all voltages show for the 15KP Series. Please consult the factory for other voltages.							
15KP280A	280.0	311.0	452.0	33.0	10	15	THRU-HOLE (KP Series)
Note: Part numbers shown are unidirectional devices. Add a "CA" suffix to specify bidirectional devices, such as '15KP280CA'.							
60KS200C	180.0	200.0	335.0	180.0	10	60kW @ 1.2/50 μ s	
90KS200C	180.0 180.0	200.0 200.0	280.0 335.0	180.0 270.0	0.5 0.5	90kW @ 1.2/50 μ s	
704-15K36	31.5	36.0	53.0	300.0	100	15	
704-15K36P	31.5	36.0	53.0	300.0	100	15	
704-15K36T	31.5	36.0	53.0	300.0	500	15	
GPZ532	28.0	32.0	40.0	100	50	10kW @ 1ms	
GPZ1275	28.0	32.0	55.0	500	60	30kW @ 1ms	
GPZ1275B60K	28.0	32.0	55.0	1000	60	60kW @ 1ms	

Note: I_{PP} @ 1 ms for GPZ Series.

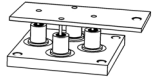
HIGH POWERED MODULES							PACKAGE
PART NUMBER	STAND-OFF VOLTAGE - V_{WM}	MIN. BREAKDOWN VOLTAGE - V_{BR}	CLAMPING VOLTAGE - V_c	CURRENT I_{PP} @ 10/1000 μ s - A	LEAKAGE CURRENT - μ A @ V_{WM}	POWER @ 10/1000 μ s - kW	
PHP8.4	12.0	14.0	22.0	341.0	250	7.5	
PHP24	34.0	40.0	67.0	112.0	250	7.5	
PHP30	42.5	50.0	84.0	90.0	250	7.5	
PHP60	85.0	100.0	167.0	90.0	250	15	
PHP120*	170.0	200.0	319.0	47.0	250	15	
PHP208	295.0	347.0	536.0	28.0	250	15	
PHP250*	354.0	418.0	652.0	23.0	250	15	
PHP275	390.0	460.0	710.0	21.0	250	15	
PHP440	623.0	735.0	1138.0	13.2	250	15	
PHP500*	708.0	835.0	1292.0	11.6	250	15	
PIP8.4	12.0	14.0	22.0	341.0	250	7.5	
PIP24	34.0	40.0	67.0	112.0	250	7.5	
PIP30	42.5	50.0	84.0	90.0	250	7.5	
PIP60	85.0	100.0	167.0	90.0	250	15	
PIP120*	170.0	200.0	319.0	47.0	250	15	
PIP208	295.0	347.0	536.0	28.0	250	15	
PIP250*	354.0	418.0	652.0	23.0	250	15	
PIP440	623.0	735.0	1138.0	13.2	250	15	
PIP500*	708.0	835.0	1292.0	11.6	250	15	
Note: PHP Series is typically used in Aerospace applications. PIP Series is typically used in Industrial applications. *Indicates marine applications.							
PNH1275	28	32	52	865	60	45kW 1ms	
PNH1275B	28	32	52	865	60	45kW 1ms	
PPZ516	14	16	20	200	40	20kW 1ms	
PPZ516B	14	16	20	200	40	20kW 1ms	

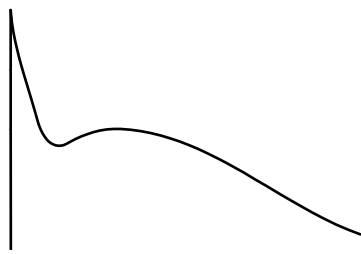

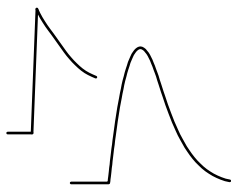
International Standard	Environmental Threat	Transient Characteristics	Test Waveform
61000-4-2	ESD	Super Fast < 1ns Low Energy	
61000-4-4	EFT	Fast 5 ns Medium Energy (per burst)	
61000-4-5	Surge	Surge 10-700 μs High Energy	

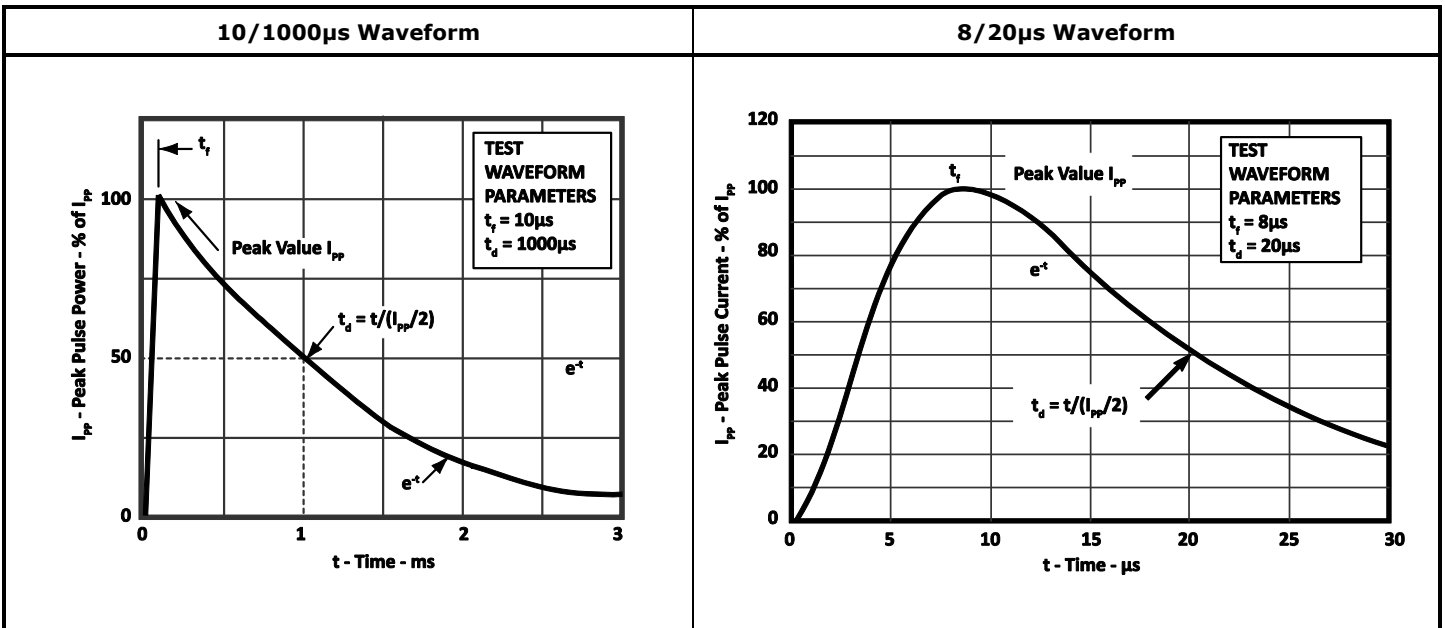

IMPULSE WAVE FORMS – UNIVERSAL WAVESHAPES

Impulses

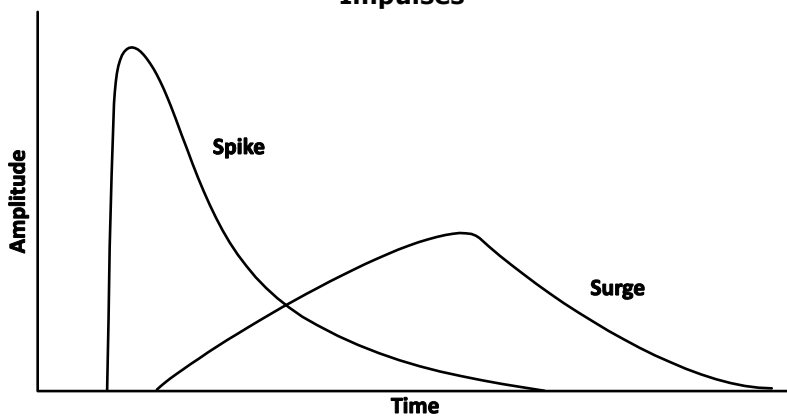

Damped Sinusoidal

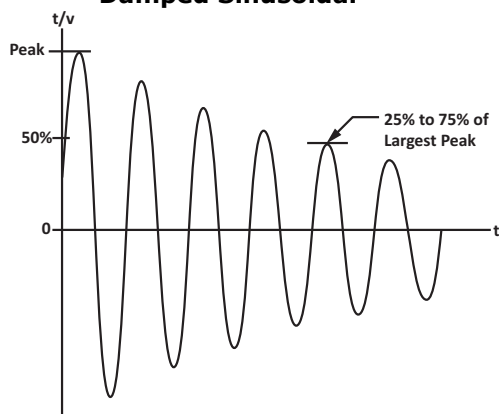

Peak Pulse Current (Amplitude)
 Pulse Duration (Time) – Spike
 Pulse Duration (Time) – Transient
 Pulse Duration (Time) – Surge

$I_t = I_{PP} = 10, 100, 1000 \text{ Amp}$
 $t_d = 30\text{ns (ESD)}$
 $t_d = 20 \text{ or } 1000\mu\text{s (Lightning)}$
 $t_d = 100\text{ms (Switching)}$

WAVEFORM 3a PIN INJECTION – 1MHz ($\pm 20\%$)(800kHz – 1200kHz Damped Sine Wave)

Level	V. Test (pk) in V	I Limit (pk) in A	DO-160G Waveform
1	107	4	
2	268	10	
3	655	24	
4	1620	60	
5	3450	128	

WAVEFORM 4 PIN INJECTION – 6.4µs/69.0µs (±20%)(5.12µs - 7.68µ)(55.2µs - 82.8µs)			
Level	Open Circuit Voltage in V	Short Circuit Current in A	DO-160G Waveform
1	53	10	
3	314	60	
5	1690	320	

WAVEFORM 5a PIN INJECTION – 40.0µs/120.0µs (±20%)(32.0µs - 48.0µs)(96.0µs - 144.0µs)			
Level	Open Circuit Voltage in V	Short Circuit Current in A	DO-160G Waveform
1	52	53	
2	128.4	136	
3	304	326	
4	758	800	
5	1630	1752	

PRODUCT PACKAGING

Nominal: Scaled 1"-1"

Not All Package Configurations Shown



0402/U0402
 Width: 0.019" (0.48)
 Length: 0.039" (1.00)
 Height: 0.016" (0.41)
 LD Pitch: N/A
 Pad Count: 2



0404
 Width: 0.039" (1.00)
 Length: 0.039" (1.00)
 Height: 0.016" (0.41)
 LD Pitch: N/A
 Pad Count: 4



CDIP-16
 Width: 0.47" (11.94)
 Length: 0.90" (22.86)
 Height: 0.192" (4.83)
 LD Pitch: 0.100" (2.54)
 Pin Count: 16



DFN-2-0201(0603)
 Width: 0.012" (0.30)
 Length: 0.025" (0.64)
 Height: 0.012" (0.30)
 LD Pitch: N/A
 Pad Count: 2



DFN-2-0402
 Width: 0.024" (0.61)
 Length: 0.040" (1.02)
 Height: 0.018" (0.46)
 LD Pitch: N/A
 Pad Count: 2



DFN-2-KW
 Width: 0.36" (9.14)
 Length: 0.434" (11.05)
 Height: 0.12" (3.05)
 LD Pitch: 0.179" (4.50)
 Pad Count: 2



DFN-4
 Width: 0.040" (1.02)
 Length: 0.040" (1.02)
 Height: 0.020" (0.50)
 LD Pitch: N/A
 Pad Count: 4



DFN-6
 Width: 0.059" (1.50)
 Length: 0.077" (1.96)
 Height: 0.019" (0.48)
 LD Pitch: 0.020" (0.50)
 Pad Count: 6



DFN-8
 Width: 0.079" (2.00)
 Length: 0.079" (2.00)
 Height: 0.031" (0.80)
 LD Pitch: 0.020" (0.50)
 Pad Count: 8



DFN-10
 Width: 0.101" (2.57)
 Length: 0.101" (2.57)
 Height: 0.019" (0.48)
 LD Pitch: 0.020" (0.50)
 Pad Count: 10



DFN-12
 Width: 0.063" (1.60)
 Length: 0.118" (3.00)
 Height: 0.022" (0.55)
 LD Pitch: 0.020" (0.50)
 Pad Count: 12



DFN-16
 Width: 0.063" (1.60)
 Length: 0.158" (4.00)
 Height: 0.031" (0.79)
 LD Pitch: 0.020" (0.50)
 Pad Count: 16



DIP-8
 Width: 0.250" (6.35)
 Length: 0.39" (9.91)
 Height: 0.160" (4.06)
 LD Pitch: 0.100" (2.54)
 Pin Count: 8

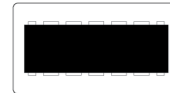

DIP-14
 Width: 0.250" (6.35)
 Length: 0.740" (18.80)
 Height: 0.160" (4.06)
 LD Pitch: 0.100" (2.54)
 Pin Count: 14

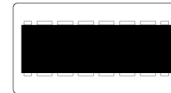

DIP-16
 Width: 0.250" (6.35)
 Length: 0.755" (19.18)
 Height: 0.160" (4.06)
 LD Pitch: 0.100" (2.54)
 Pin Count: 16



DO-214AA
 Width: 0.17" (4.32)
 Length: 0.14" (3.56)
 Height: 0.089" (2.25)
 LD Pitch: N/A
 Pin Count: 2



DO-214AB
 Width: 0.27" (6.86)
 Length: 0.23" (5.84)
 Height: 0.089" (2.25)
 LD Pitch: N/A
 Pin Count: 2



DO-214AC
 Width: 0.17" (4.32)
 Length: 0.10" (2.54)
 Height: 0.08" (2.03)
 LD Pitch: N/A
 Pin Count: 2

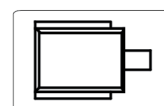

DO-218
 Width: 0.40" (10.00)
 Length: 0.60" (15.50)
 Height: 0.19" (5.0)
 LD Pitch: N/A
 Pin Count: 1



SC-70-5L
 Width: 0.050" (1.27)
 Length: 0.079" (2.00)
 Height: 0.035" (0.89)
 LD Pitch: 0.025" (0.64)
 Pin Count: 5



SC-70-6L
 Width: 0.050" (1.27)
 Length: 0.079" (2.00)
 Height: 0.035" (0.89)
 LD Pitch: 0.025" (0.64)
 Pin Count: 6



SC-79
 Width: 0.032" (0.81)
 Length: 0.046" (1.17)
 Height: 0.024" (0.61)
 LD Pitch: N/A
 Pin Count: 2



SC-89
 Width: 0.047" (1.19)
 Length: 0.063" (1.60)
 Height: 0.022" (0.55)
 LD Pitch: 0.020" (0.50)
 Pin Count: 6



SO-8
 Width: 0.192" (4.90)
 Length: 0.15" (3.81)
 Height: 0.061" (1.55)
 LD Pitch: 0.050" (1.27)
 Pin Count: 8



SO-14
 Width: 0.15" (3.81)
 Length: 0.34" (8.63)
 Height: 0.061" (1.55)
 LD Pitch: 0.050" (1.27)
 Pin Count: 14

PRODUCT PACKAGING

Nominal: Scaled 1"-1"

Not All Package Configurations Shown

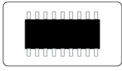

SO-16

Width: 0.15" (3.81)
Length: 0.390" (9.90)
Height: 0.061" (1.55)
LD Pitch: 0.050" (1.27)
Pin Count: 16

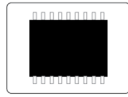

SO-16WB

Width: 0.295" (7.50)
Length: 0.405" (10.30)
Height: 0.097" (2.46)
LD Pitch: 0.050" (1.27)
Pin Count: 16



SOD-323

Width: 0.051" (1.30)
Length: 0.69" (1.75)
Height: 0.037" (0.94)
LD Pitch: N/A
Pin Count: 2



SOD-723

Width: 0.024" (0.61)
Length: 0.040" (1.02)
Height: 0.022" (0.56)
LD Pitch: N/A
Pin Count: 2



SOD-923

Width: 0.024" (0.60)
Length: 0.031" (0.79)
Height: 0.015" (0.37)
LD Pitch: N/A
Pin Count: 2



SOT-143

Width: 0.051" (1.30)
Length: 0.115" (2.92)
Height: 0.039" (1.00)
LD Pitch: 0.075" (1.90)
Pin Count: 4



SOT-23

Width: 0.051" (1.30)
Length: 0.115" (2.92)
Height: 0.039" (1.00)
LD Pitch: 0.037" (0.95)
Pad Count: 3



SOT-23-6

Width: 0.065" (1.65)
Length: 0.115" (2.92)
Height: 0.047" (1.19)
LD Pitch: 0.037" (0.95)
Pin Count: 6



SOT-543

Width: 0.047" (1.19)
Length: 0.063" (1.60)
Height: 0.022" (0.55)
LD Pitch: 0.020" (0.50)
Pin Count: 4



SOT-553

Width: 0.047" (1.19)
Length: 0.063" (1.60)
Height: 0.022" (0.55)
LD Pitch: 0.020" (0.50)
Pin Count: 5



SOT-563

Width: 0.047" (1.19)
Length: 0.063" (1.60)
Height: 0.022" (0.55)
LD Pitch: 0.020" (0.50)
Pin Count: 6



SOT-883

Width: 0.024" (0.50)
Length: 0.039" (1.00)
Height: 0.018" (0.45)
LD Pitch: 0.014" (0.36)
Pad Count: 3



SOT-953

Width: 0.031" (0.79)
Length: 0.039" (1.00)
Height: 0.018" (0.46)
LD Pitch: 0.015" (0.38)
Pin Count: 5



SOT-963

Width: 0.031" (0.79)
Length: 0.039" (1.00)
Height: 0.018" (0.46)
LD Pitch: 0.015" (0.38)
Pin Count: 6

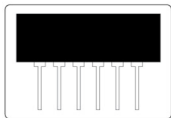

VSIP-6

Width: 0.250" (6.35)
Length: 0.780" (19.18)
Height: 0.130" (3.30)
LD Pitch: 0.100" (2.54)
Pin Count: 6

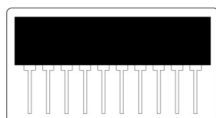

VSIP-10

Width: 0.250" (6.35)
Length: 1.020" (25.90)
Height: 0.110" (2.79)
LD Pitch: 0.100" (2.54)
Pin Count: 10

COMPANY PROFILE

In business more than 30 years, ProTek Devices™ is a privately held semiconductor company. The company offers a product line of overvoltage protection components. These include Transient Voltage Suppressor arrays (TVS arrays), Steering Diode/Hybrid arrays, Thyristor Surge Suppressors, EMI Filters, High-Powered Components and Modules as well as Chipscale TVS arrays. These devices deliver circuit protection in electronic systems from numerous overvoltage events. They include lightning; electrostatic discharge (ESD); nuclear electromagnetic pulses (NEMP); inductive switching; and electromagnetic interference (EMI) / radio frequency interference (RFI). ProTek Devices is an ISO 9001 certified company.

CONTACT US

Corporate Headquarters

2929 South Fair Lane
Tempe, Arizona 85282
USA

By Telephone

General: 602-431-8101
Sales: & Marketing: 602-414-5109
Customer Service: 602-414-5114
Product Technical Support: 602-414-5107

By Fax

General: 602-431-2288

By E-mail:

Asia Sales: asiasales@protekdevices.com
Europe Sales: europesales@protekdevices.com
U.S. Sales: ussales@protekdevices.com
Distributor Sales: distysales@protekdevices.com
Customer Service: service@protekdevices.com
Technical Support: support@protekdevices.com

ProTek Devices (Asia Pacific) Pte. Ltd.

8 Ubi Road 2, #06-19
Zervex
Singapore - 408538
Tel: +65-67488312
Fax: +65-67488313

Web

www.protekdevices.com

COPYRIGHT © ProTek Devices 2022 - This literature is subject to all applicable copyright laws and is not for resale in any manner.

SPECIFICATIONS: ProTek reserves the right to change the electrical and or mechanical characteristics described herein without notice.

DESIGN CHANGES: ProTek reserves the right to discontinue product lines without notice and that the final judgement concerning selection and specifications is the buyer's and that in furnishing engineering and technical assistance. ProTek assumes no responsibility with respect to the selection or specifications of such products. ProTek makes no warranty, representation or guarantee regarding the suitability of its products for any particular purpose, nor does ProTek assume any liability arising out of the application or use of any product or circuit and specifically disclaims any and all liability without limitation special, consequential or incidental damages.

LIFE SUPPORT POLICY: ProTek Devices products are not authorized for use in life support systems without written consent from the factory.